

A	B	C		D
1	S301-001	1863	380	3/3
2	S301-163	1946	540	1/3
3	S301-164	1946	540	1/3
4	S301-165	1501	519	1/3
5	S301-201	800	541	2/3
6	S301-345	767	537	2/3
7	S301-346	767	519	2/3
8	S301-325	374	514	2/3
9	S301-401	767	61	2/3
10	S301-901	1898	396	1/3
11	LH-351	351	14	1/3
12	DR-370	370		2/3

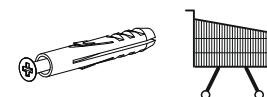

1

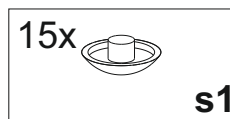
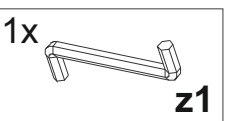
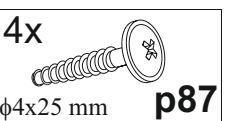
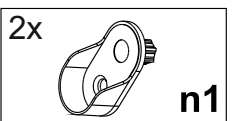
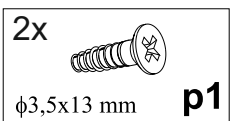
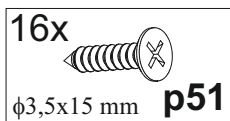
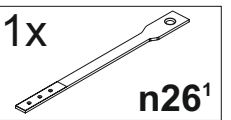
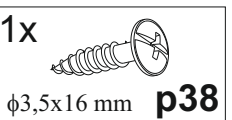
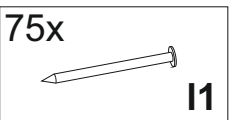
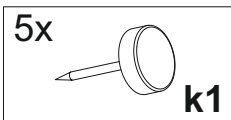
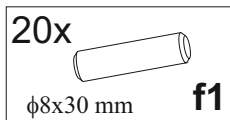
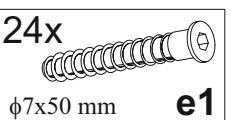
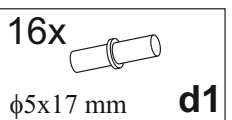
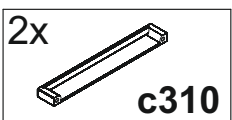
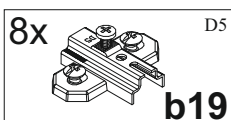
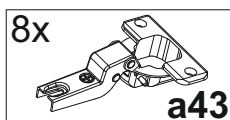
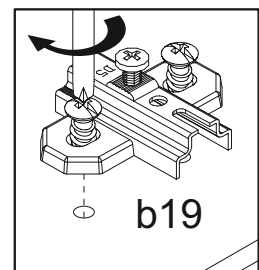
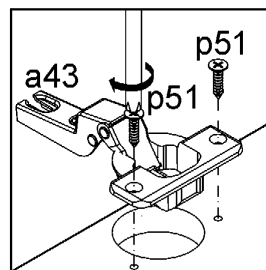
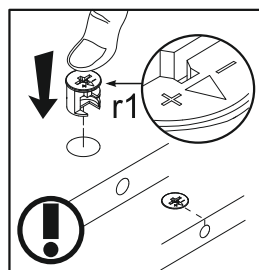
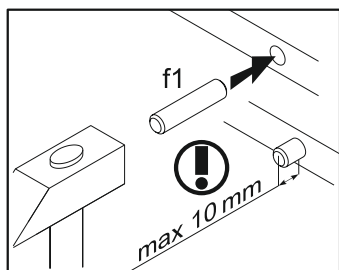
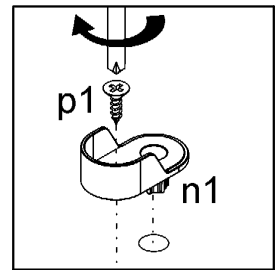
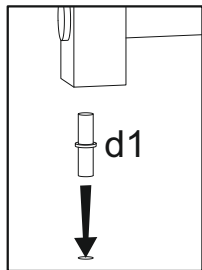
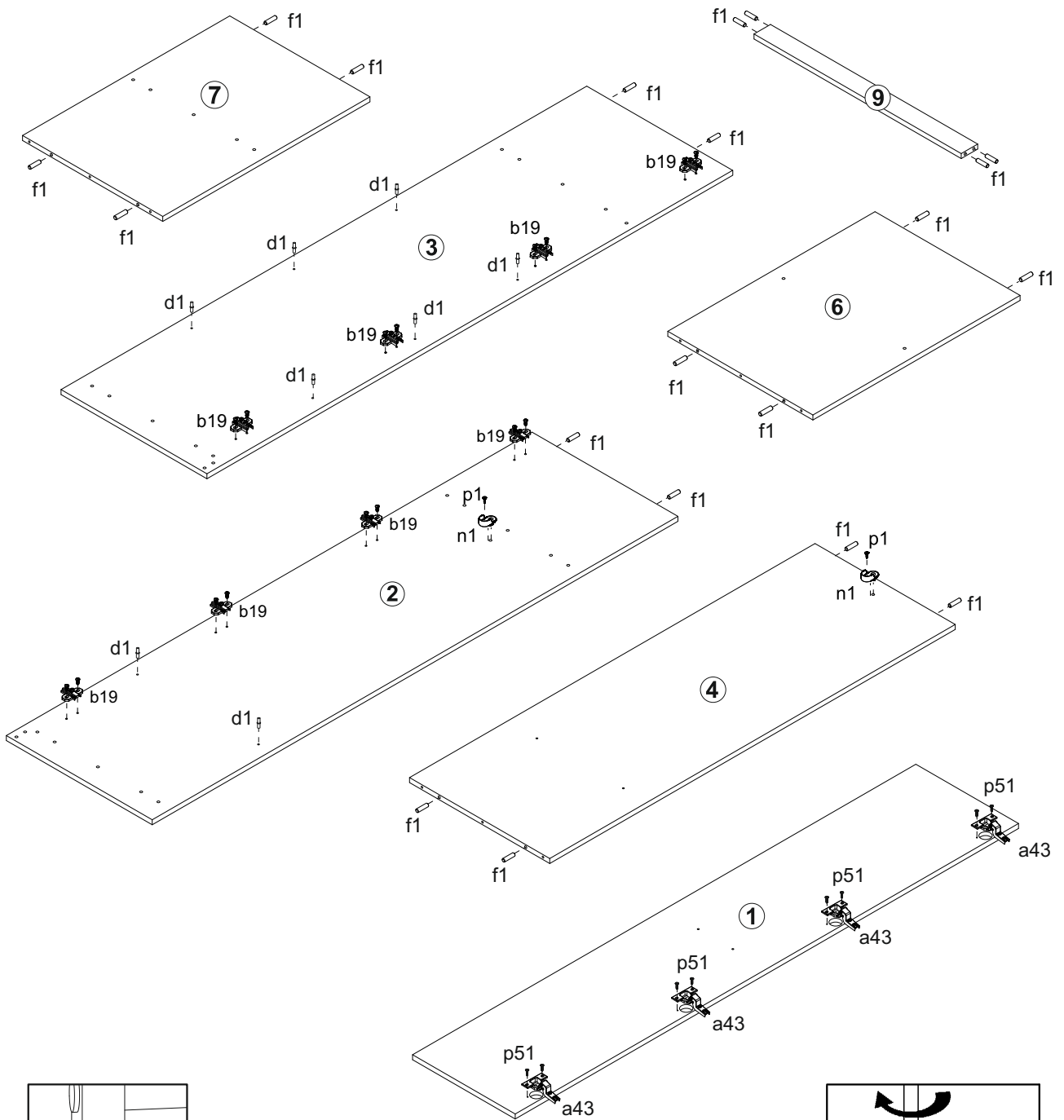

2

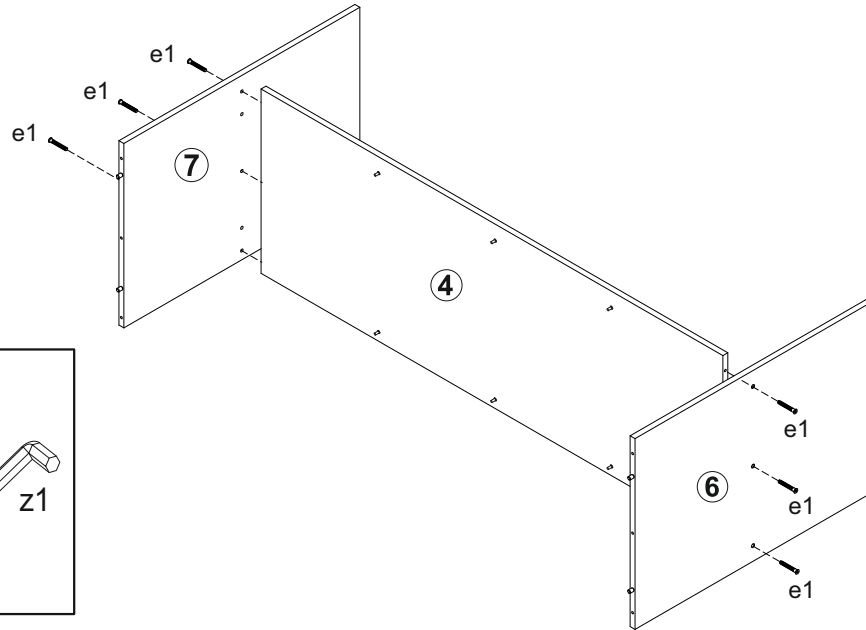

3

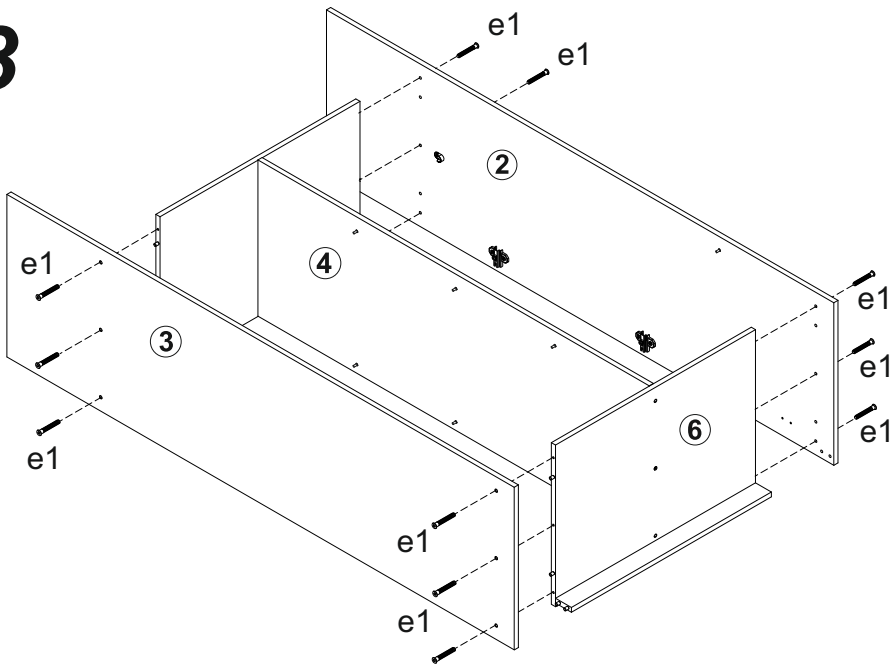

4

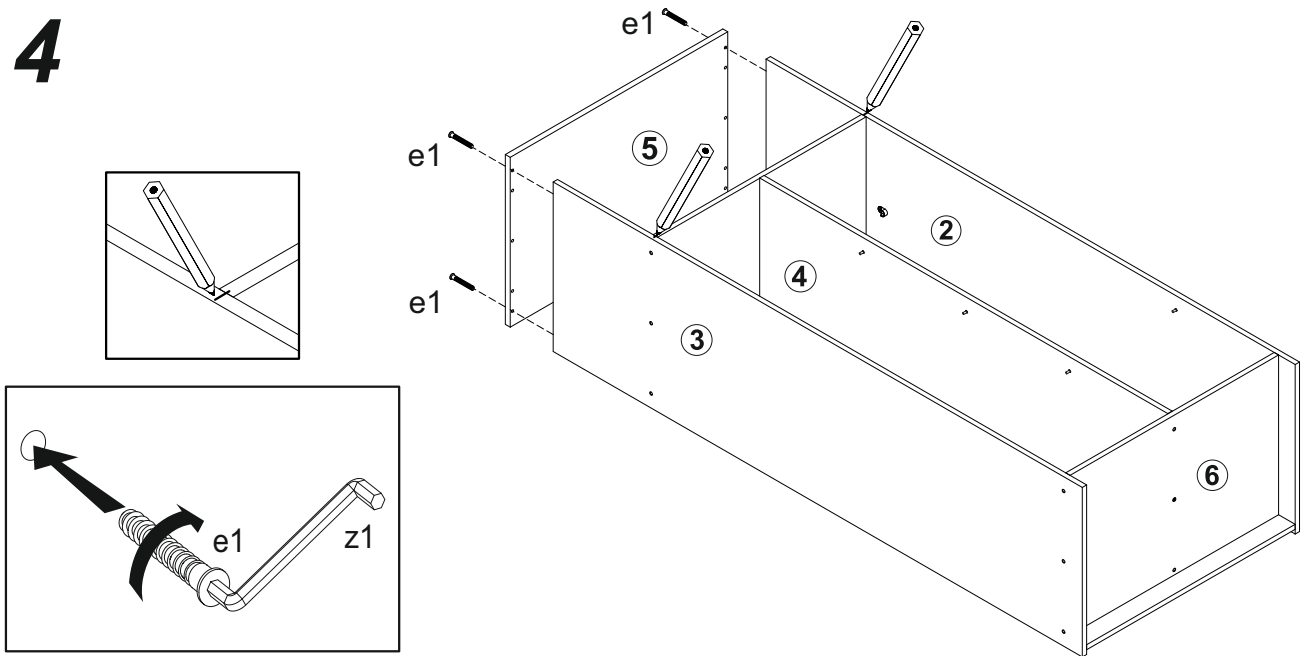

5

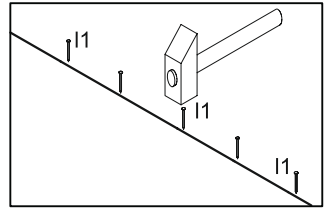
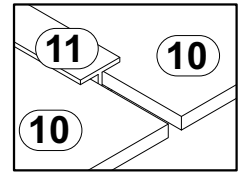
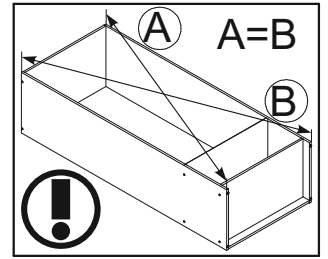
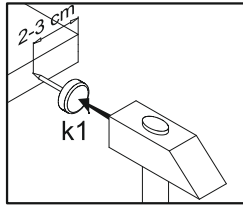
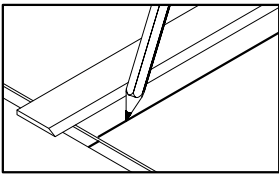
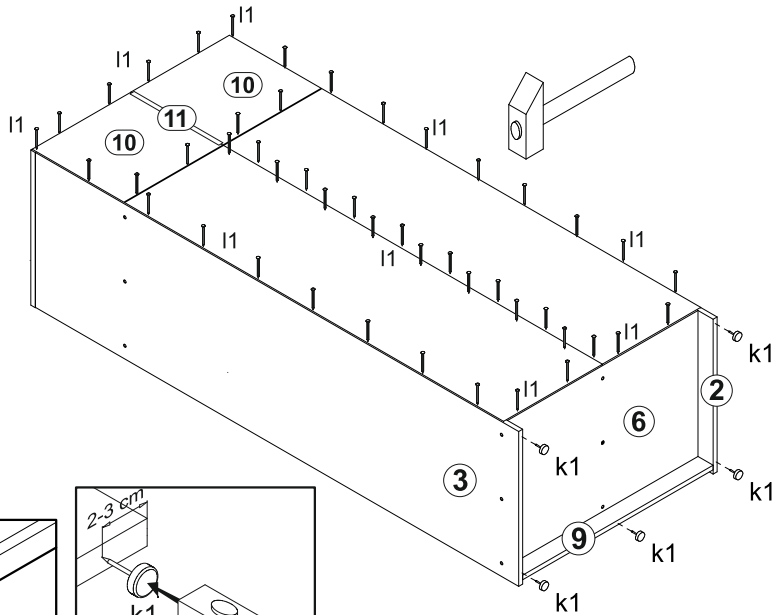

6

