

S320-KOM2D4S

A	B	C	D	A	B	C	D		
1	S320-0003	764	446	4/5	11	S320-541	441	270	3/5
2	S320-0029	764	446	4/5	12	S320-506	441	270	3/5
3	S320-0004N	596	188	5/5	13	S320-1902	816	297	1/5
4	S320-103N	772	403	1/5	14	S320-1909	816	447	1/5
5	S320-104N	772	403	1/5	15	S320-905N	537	398	1/5
6	S320-105N	772	403	1/5	16	S320-575	80	38	1/5
7	S320-106N	772	403	1/5	17	S320-569N	400	120	1/5
8	S320-2203N	1540	436	2/5	18	S320-570N	400	120	1/5
9	S320-204	1512	425	2/5	19	S320-5547N	522	120	1/5
10	S320-302	427	399	1/5	20	Lh-766	766	14	1/5

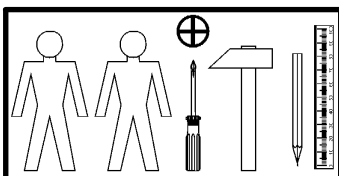
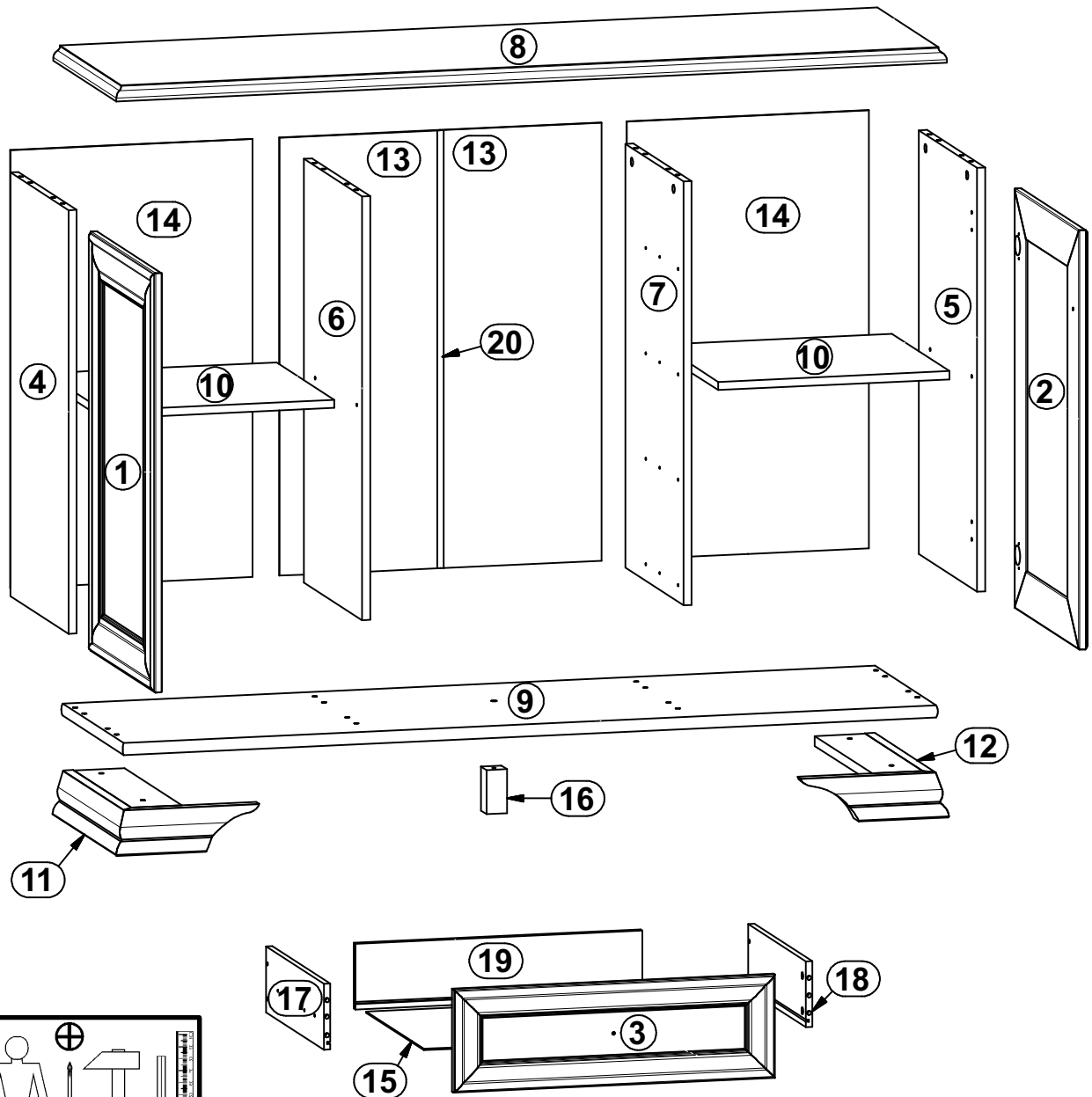
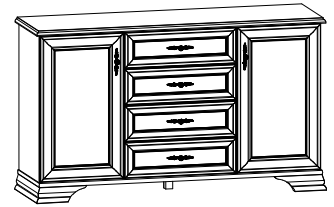

1 шт. $\phi 5 \times 60$ mm p17

1 шт. $\phi 10 \times 50$ mm f35

4x a44

4x b19

6x c35/1

6x c35/2

8x $\phi 8 \times 17$ mm d1

9x $\phi 6 \times 60$ mm e8

24x $\phi 6 \times 13$ mm e3

24x $\phi 8 \times 30$ mm f1

4x M4x18 mm j59

2x M4x30 mm j6

80x l1

24x r42

8x w208/1

8x w208/2

24x $\phi 3,5 \times 12$ mm p140

22x $\phi 16$ s2

16x $\phi 6,5 \times 40$ mm f25

8x $\phi 6,3 \times 13$ mm e2

4x $\phi 7 \times 35$ mm e26

8x $\phi 3,5 \times 15$ mm p51

24x $\phi 1,5 \times 12$ mm #16 r1

4x 383 mm t14

8x $\phi 3,5 \times 16$ mm p25

1x n26/1

1x $\phi 3,5 \times 16$ mm p38

1x z1

1

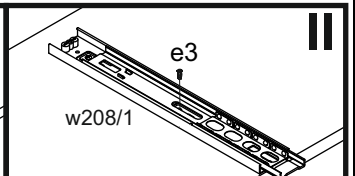
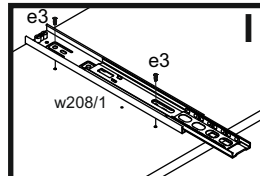
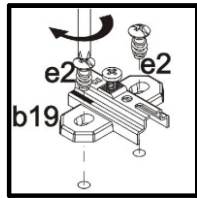
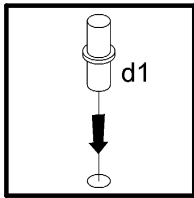
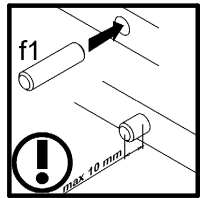
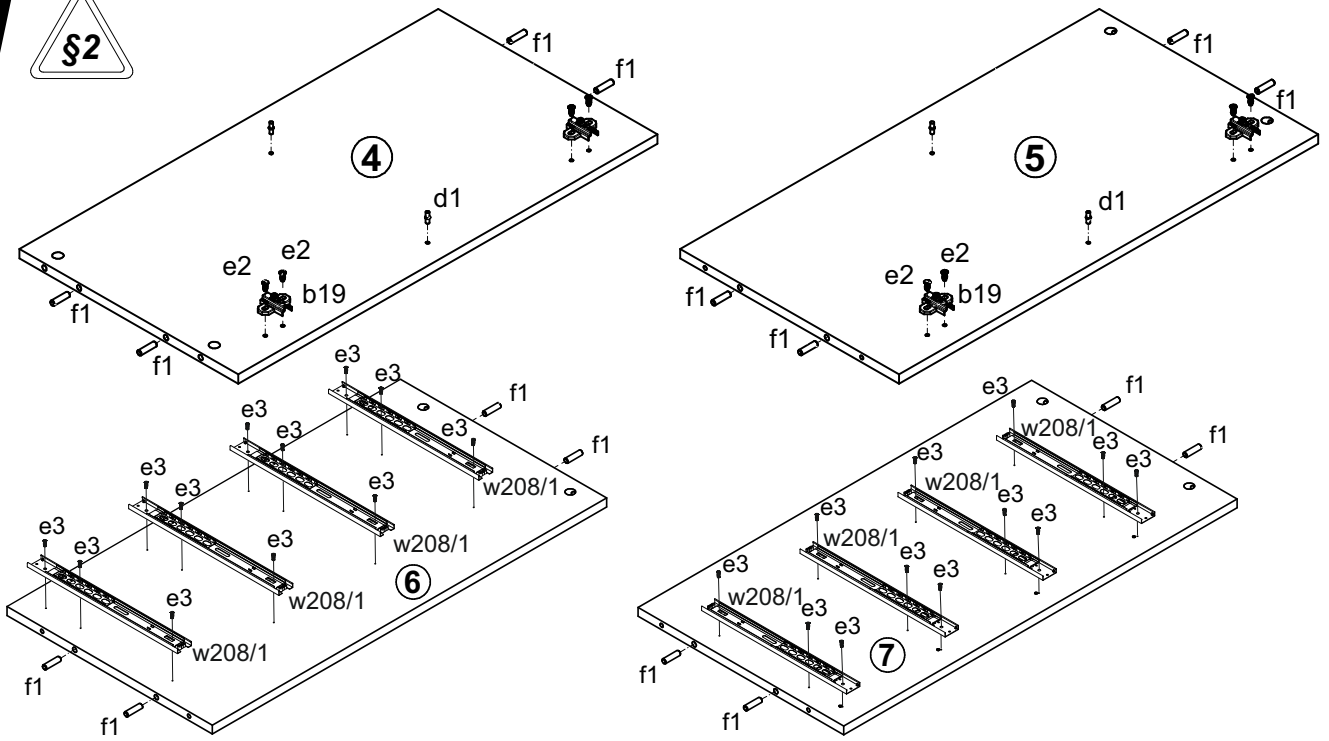

2

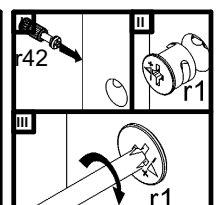
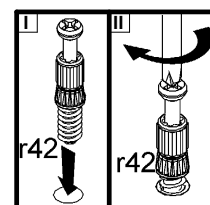
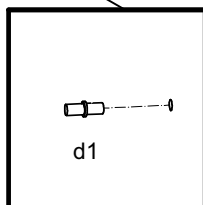
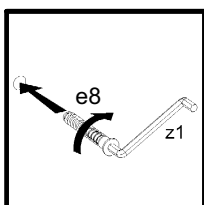
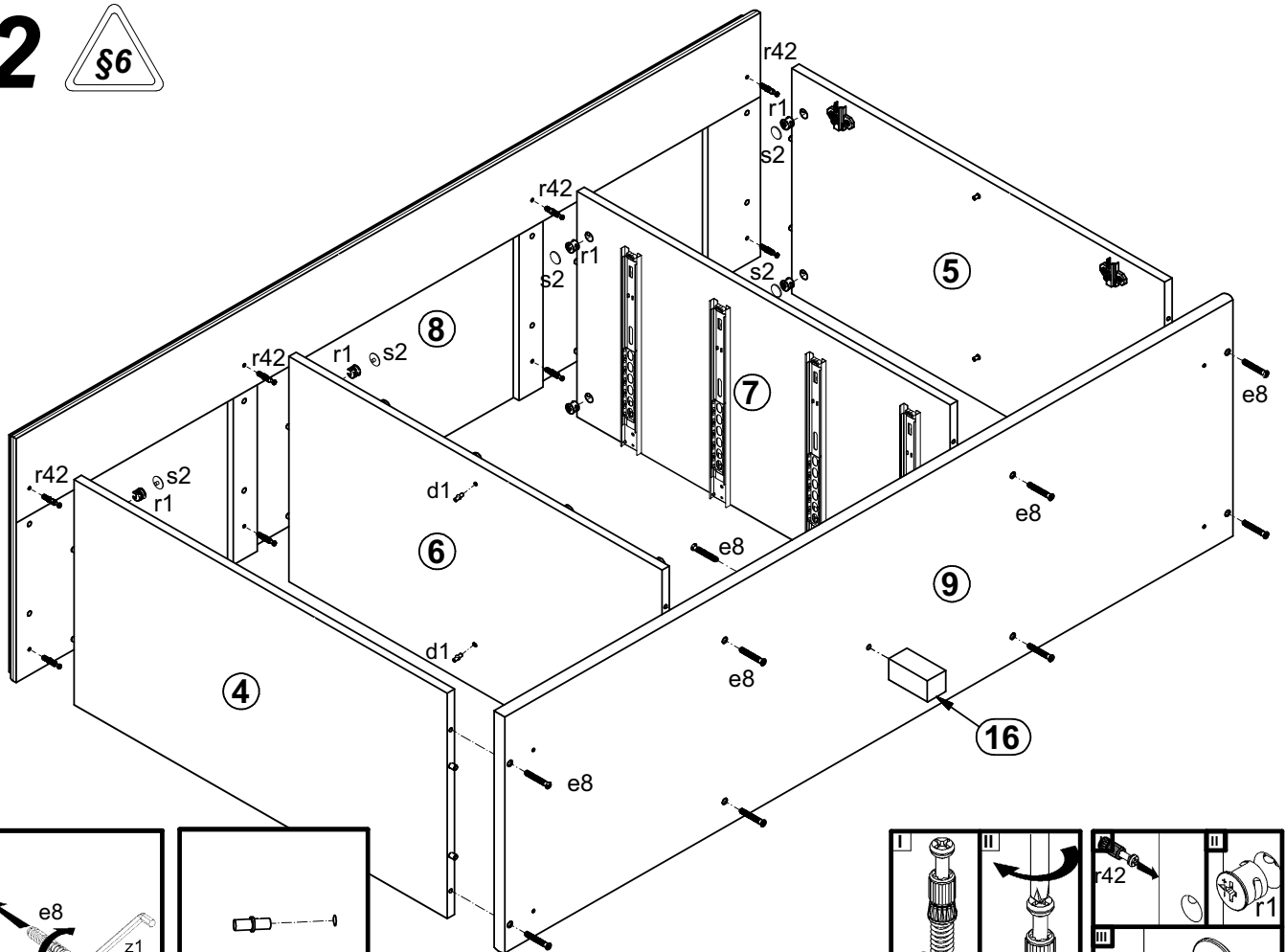

3

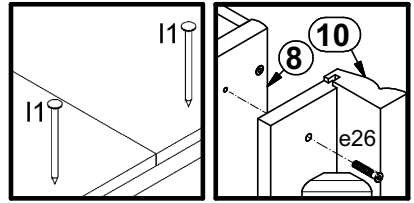
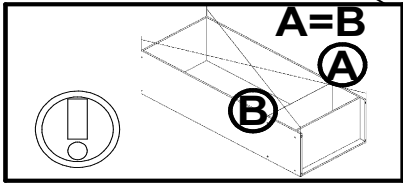
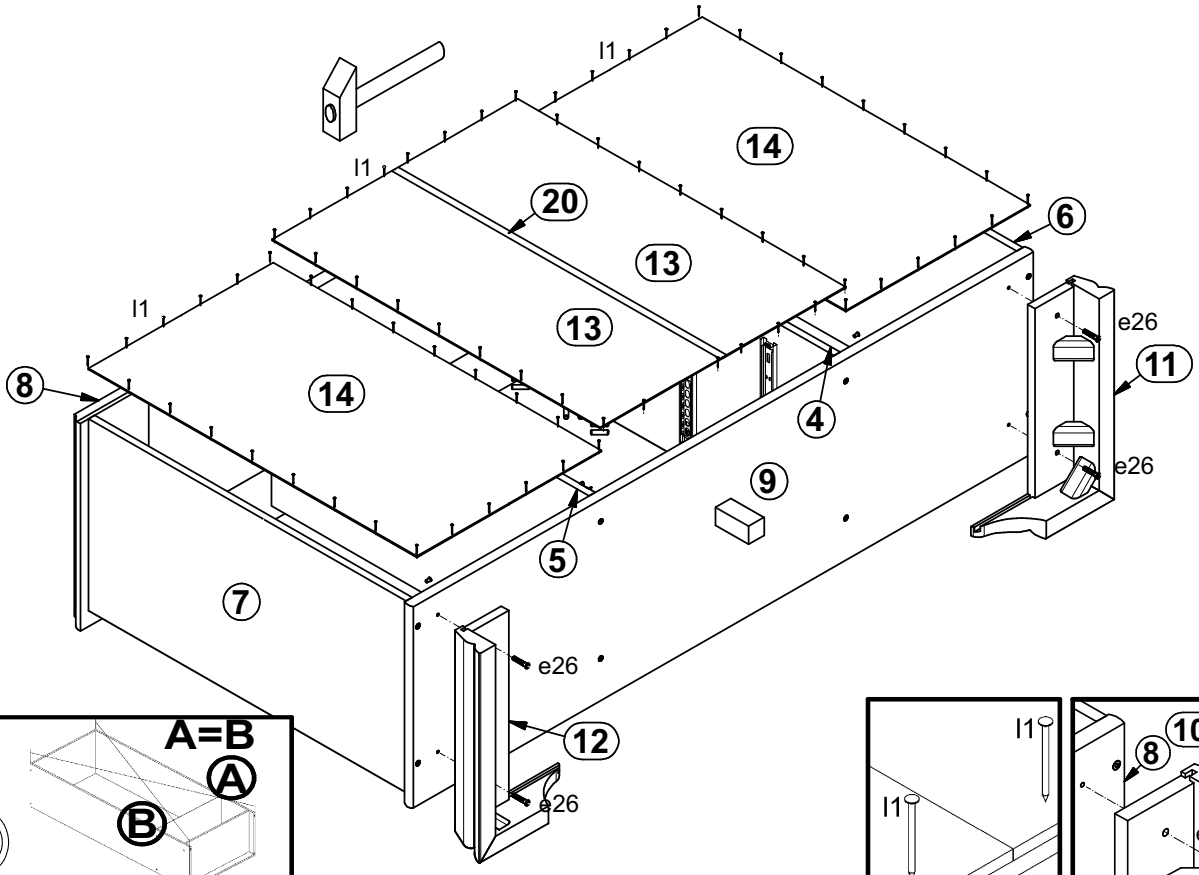

4

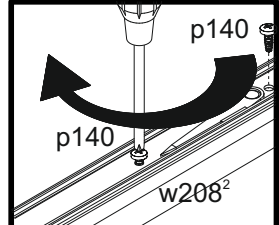
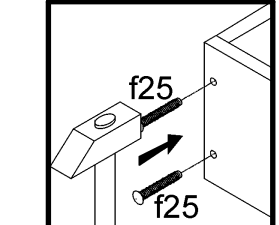
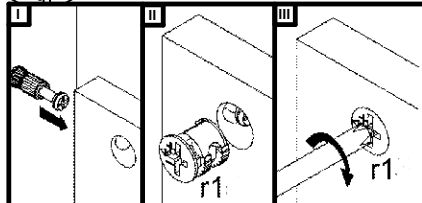
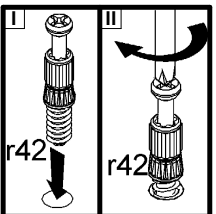
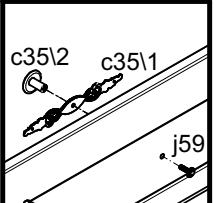
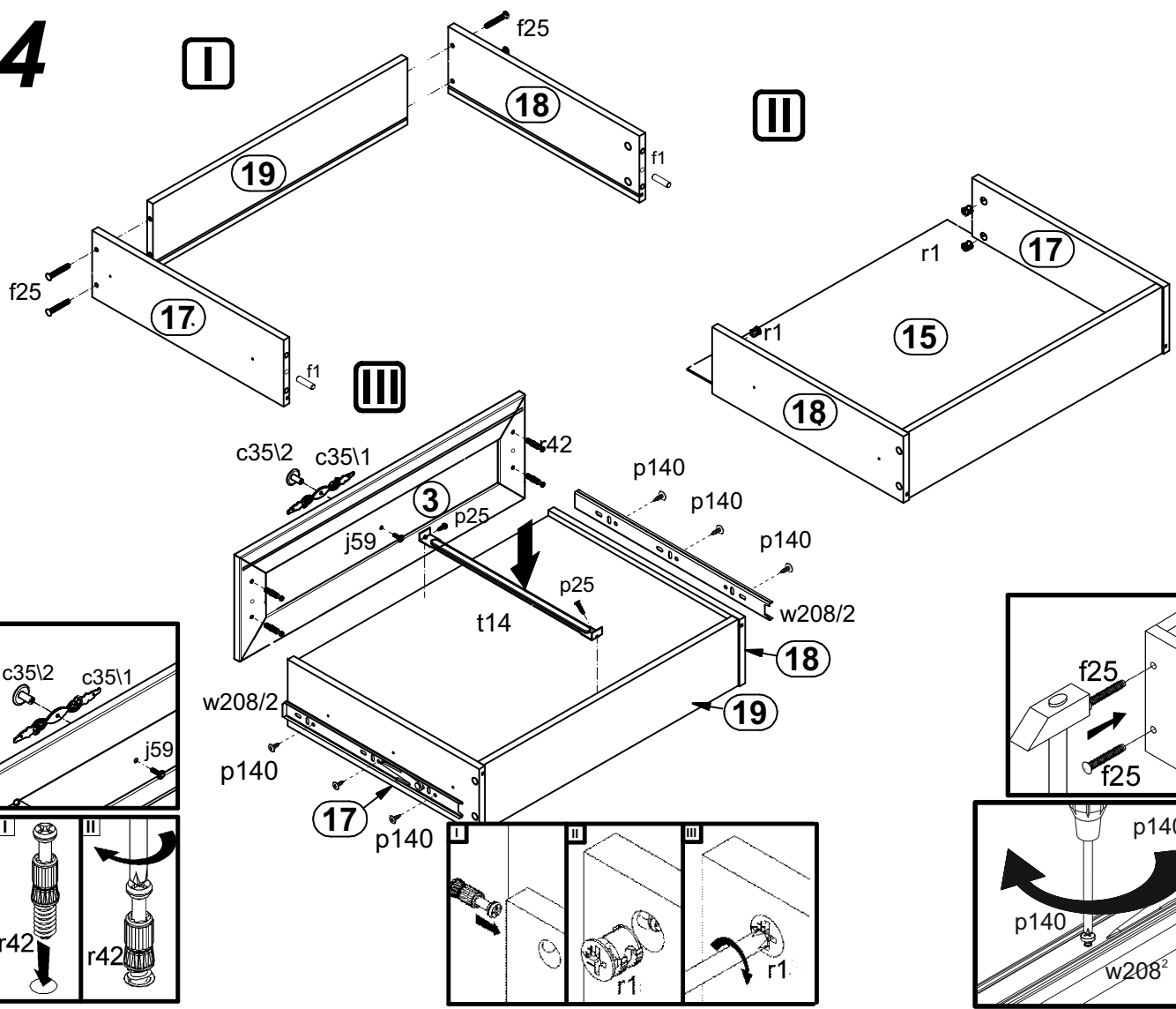

5

