

# S205-REG1W1D/21/6

A	B	C	D	
1	S205-030	604	596	2/5
2	S205-143	2043	390	1/5
3	S205-144	2043	390	1/5
4	S205-203	600	390	1/5
5	S205-204	600	390	1/5
6	S205-316	567	360	1/5
7	S205-317	566	360	1/5
8	S205-318	560	340	3/5
9	S205-322	567	354	1/5
10	S205-554	919	563	4/5
11	S205-572	567	70	2/5
12	S205-714	403	596	2/5
13	S205-722	200	596	2/5
14	S205-962	2053	288	2/5
15	S205-963	2053	288	1/5
16	Lh-2035	2035	14	1/5

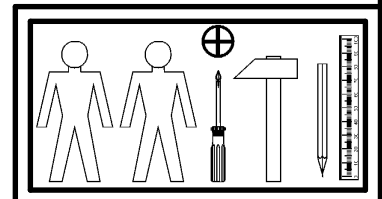
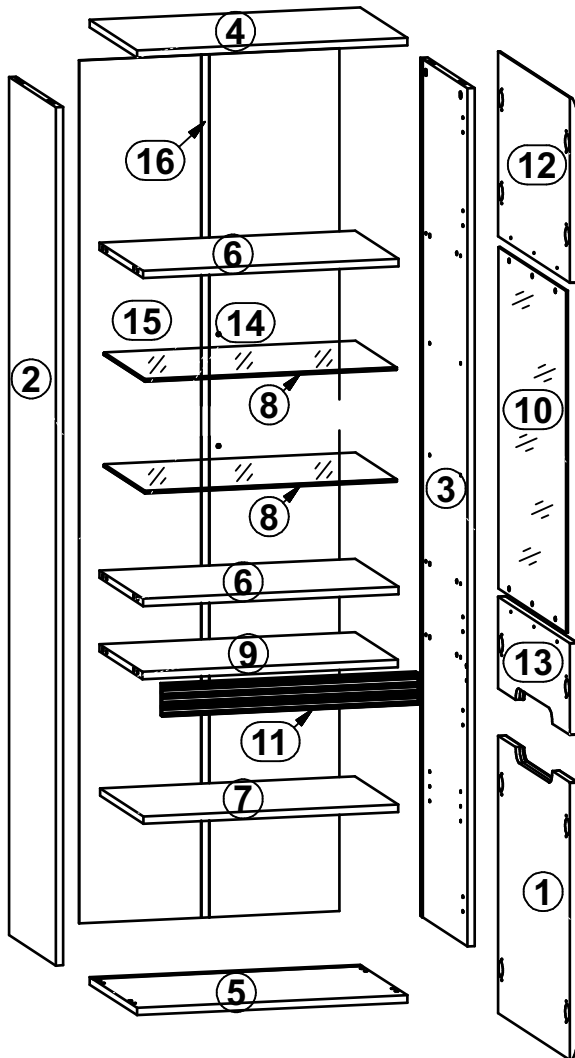
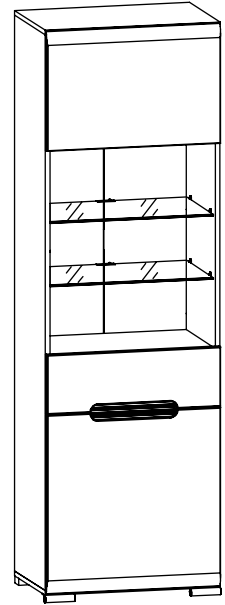
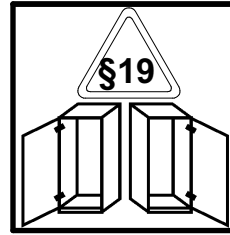

5x  a204	5x  b90	4x  d1	8x  d33	4x  e1	6x  e47	16x  f1	2x  k84	2x  k85
18x  l1	20x  l2	1x  n261	2x  o4318	1x  o4316	6x  o54	7x  p38	10x  p51	1x  p17
4x  p6	18x  r1	18x  r42	14x  s2	5x  s33	18x  s4	10x  s59	1x  z1	1x  f3

# 1

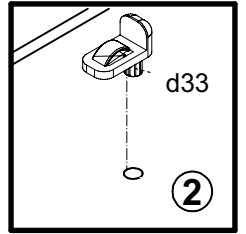
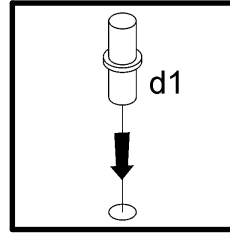
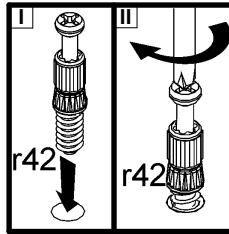
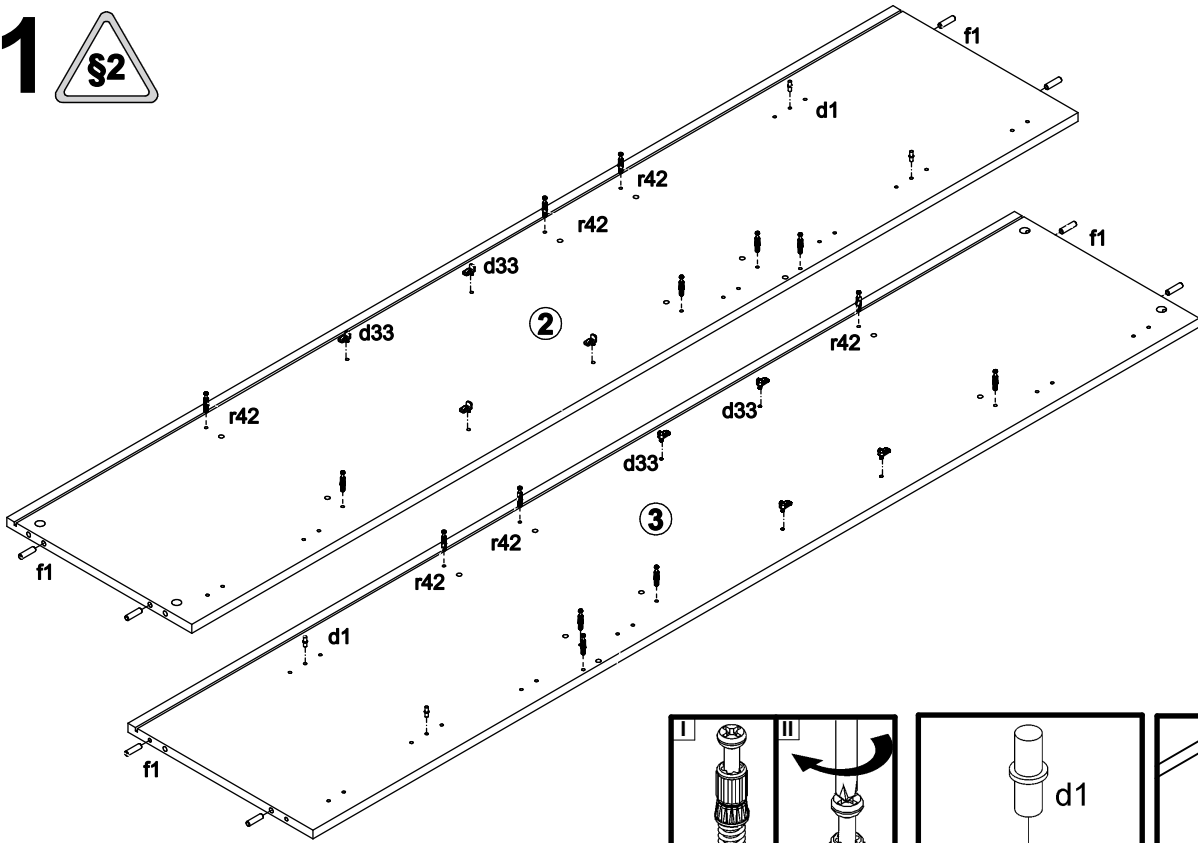

# 2

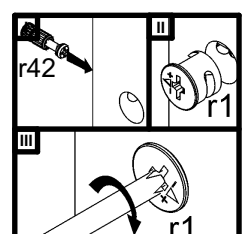
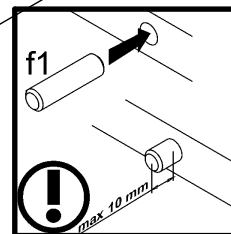
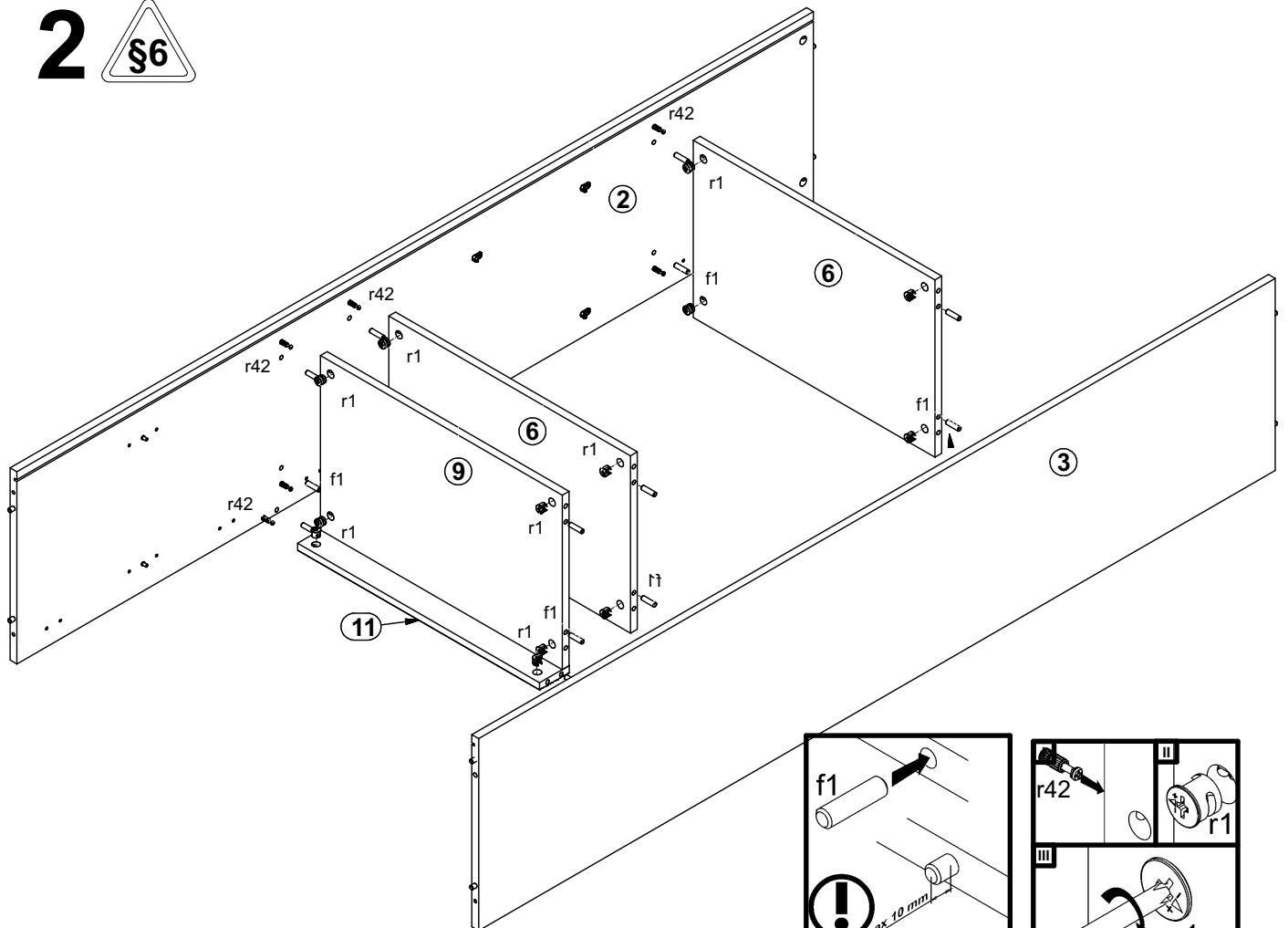

# 3

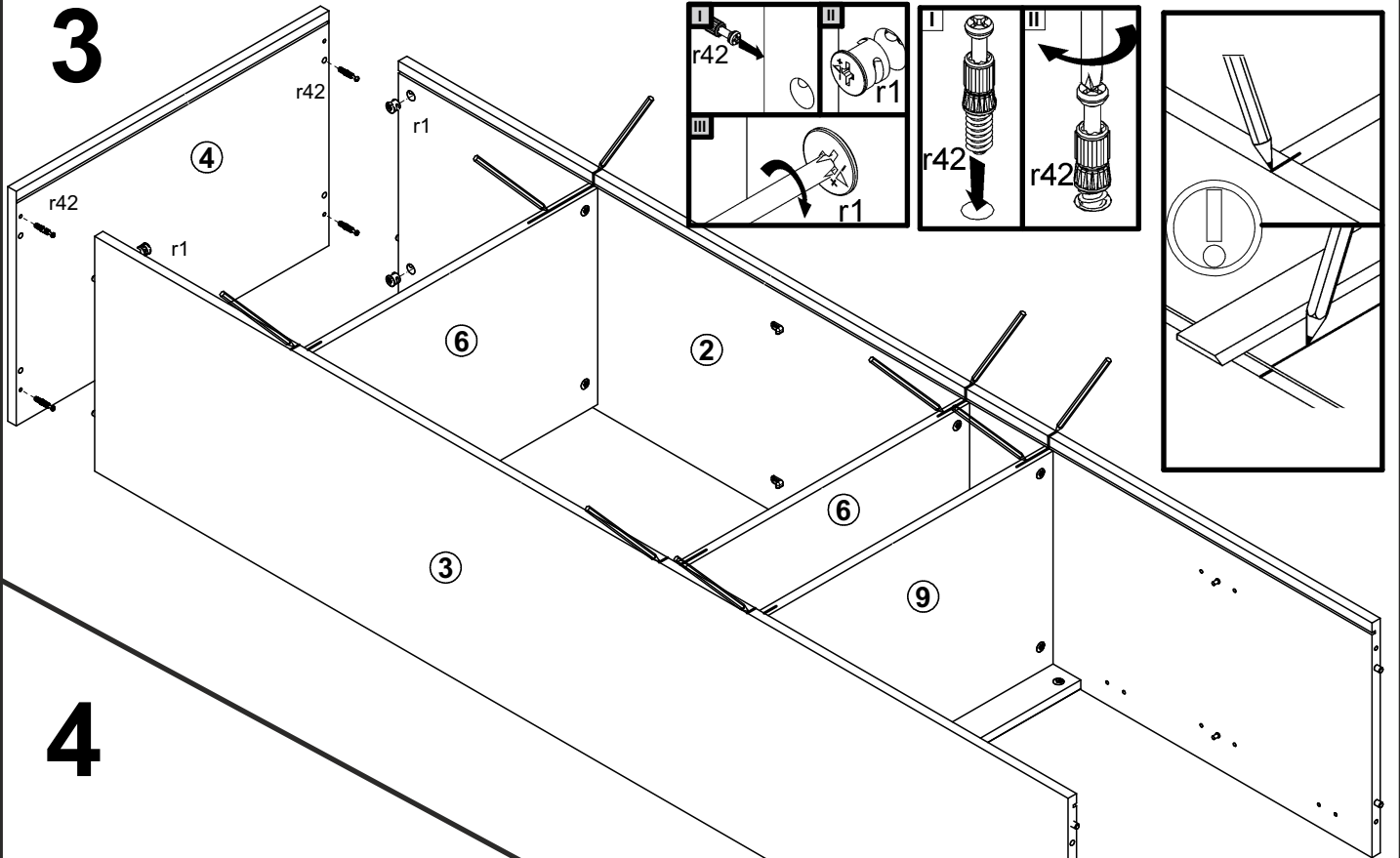

# 4

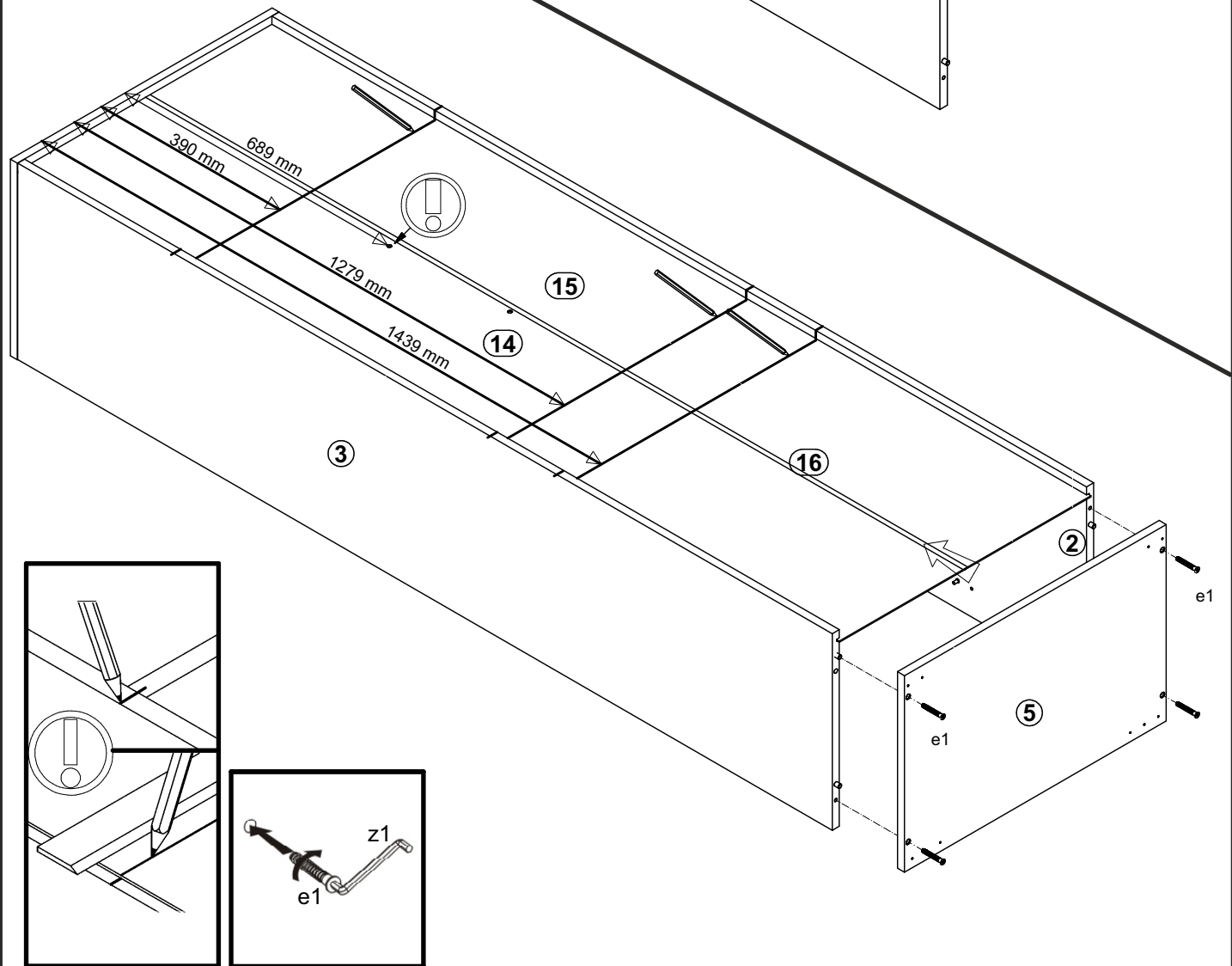

5

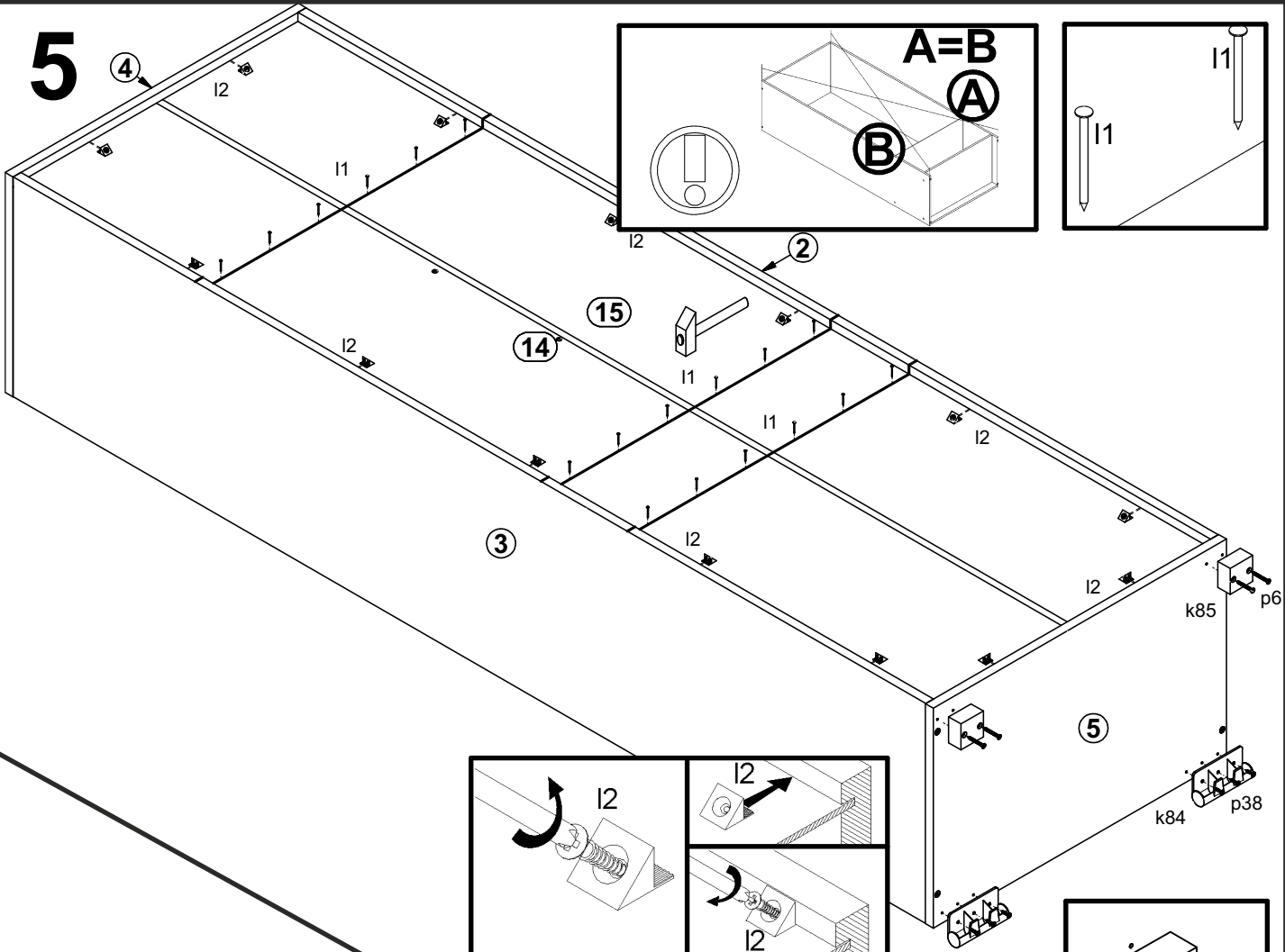

6

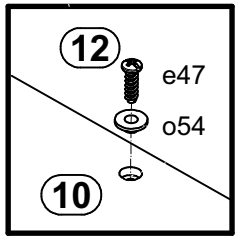
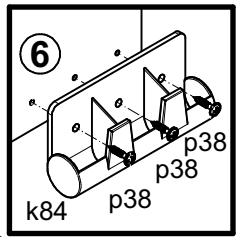
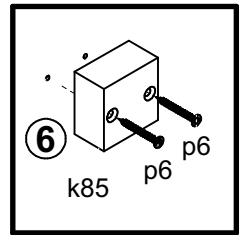
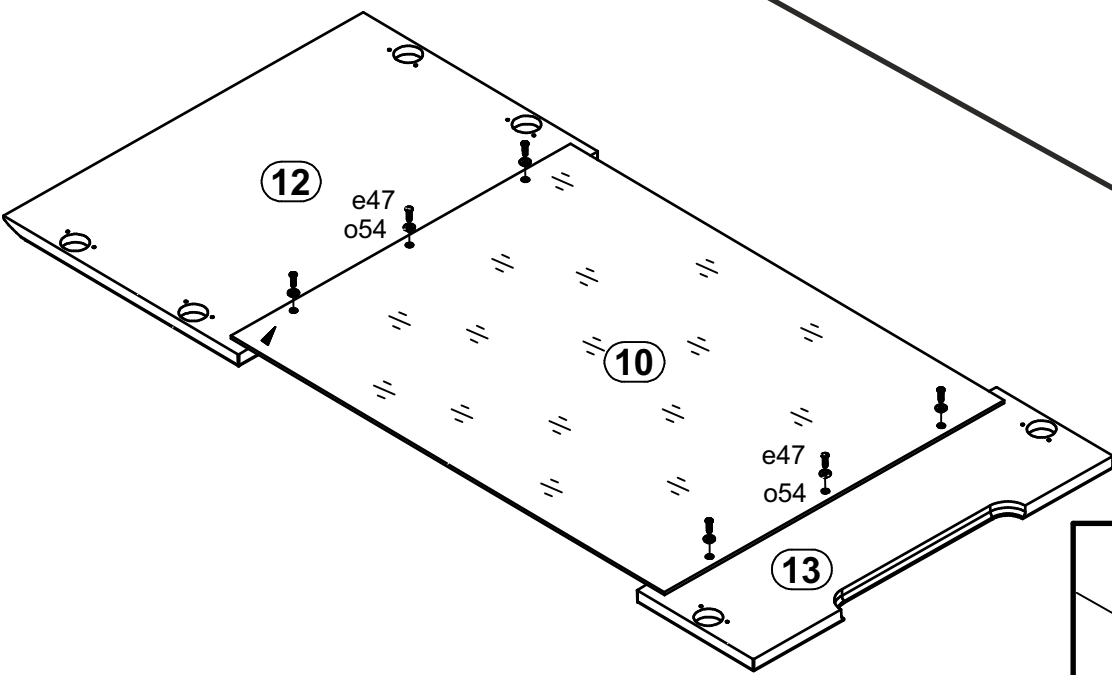

7

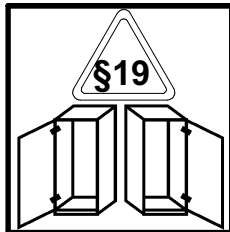
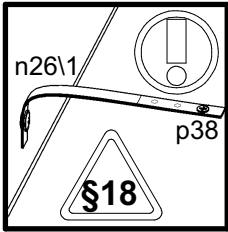

§23

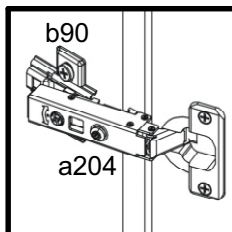
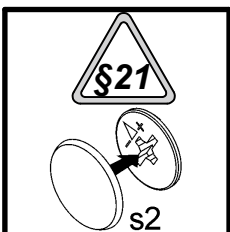
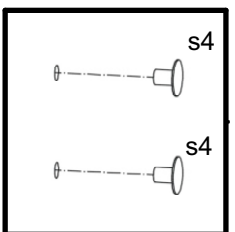
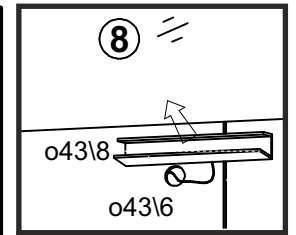
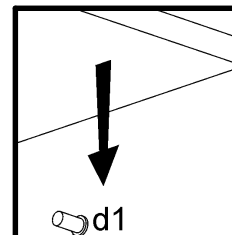
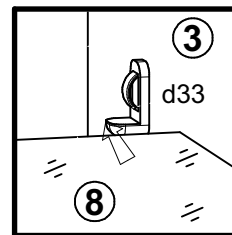
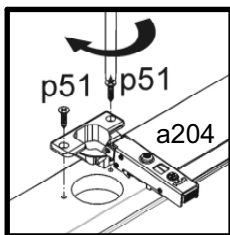
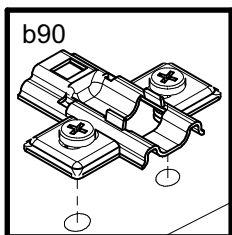
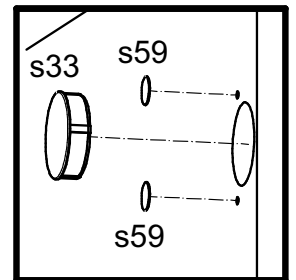
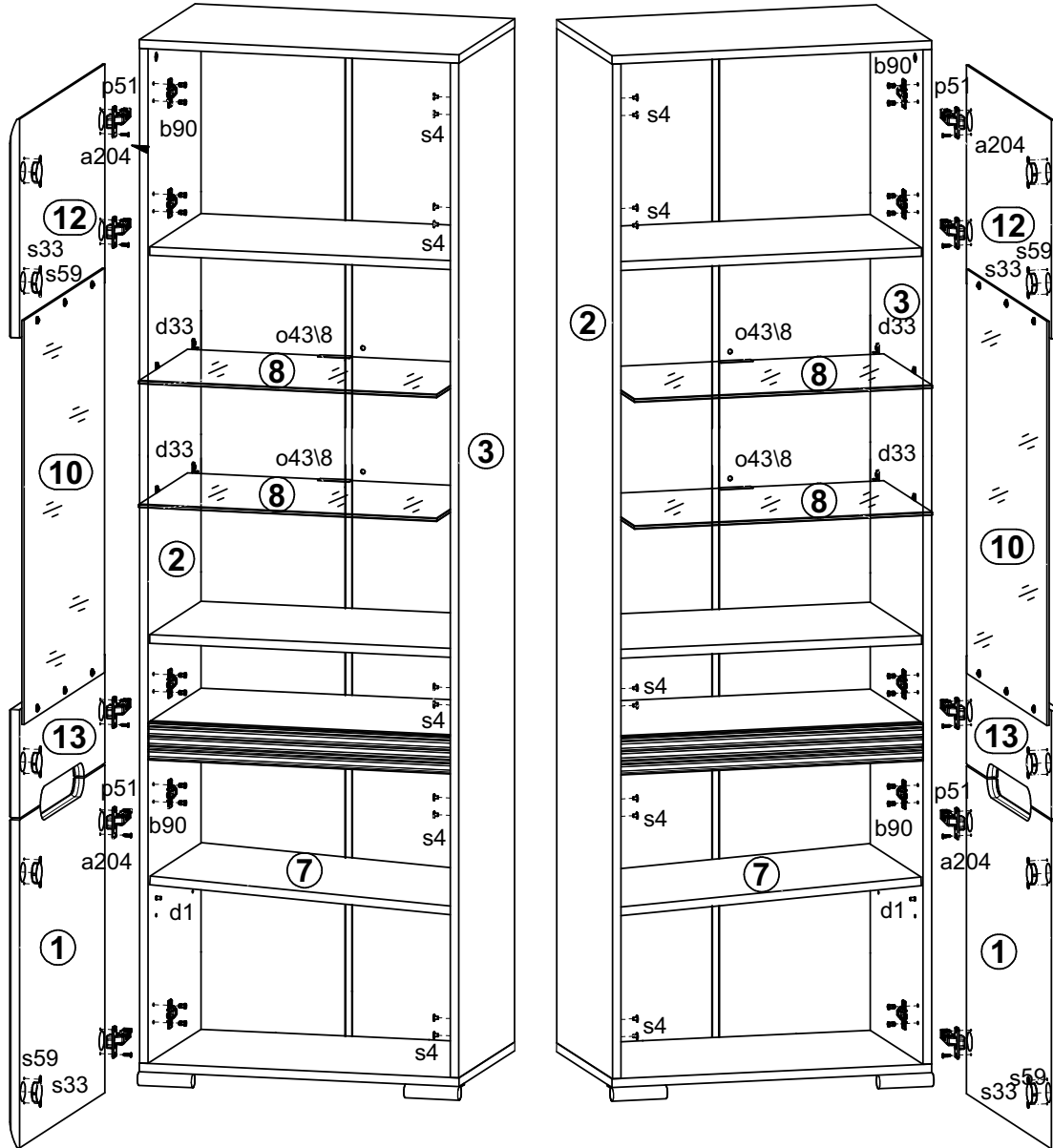
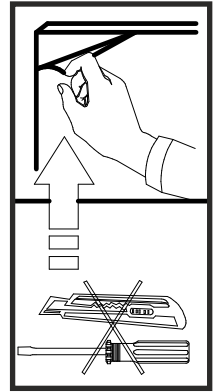

§10

