

PREMIUM

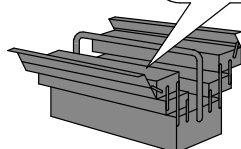

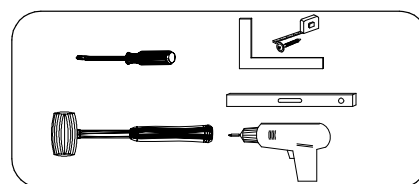
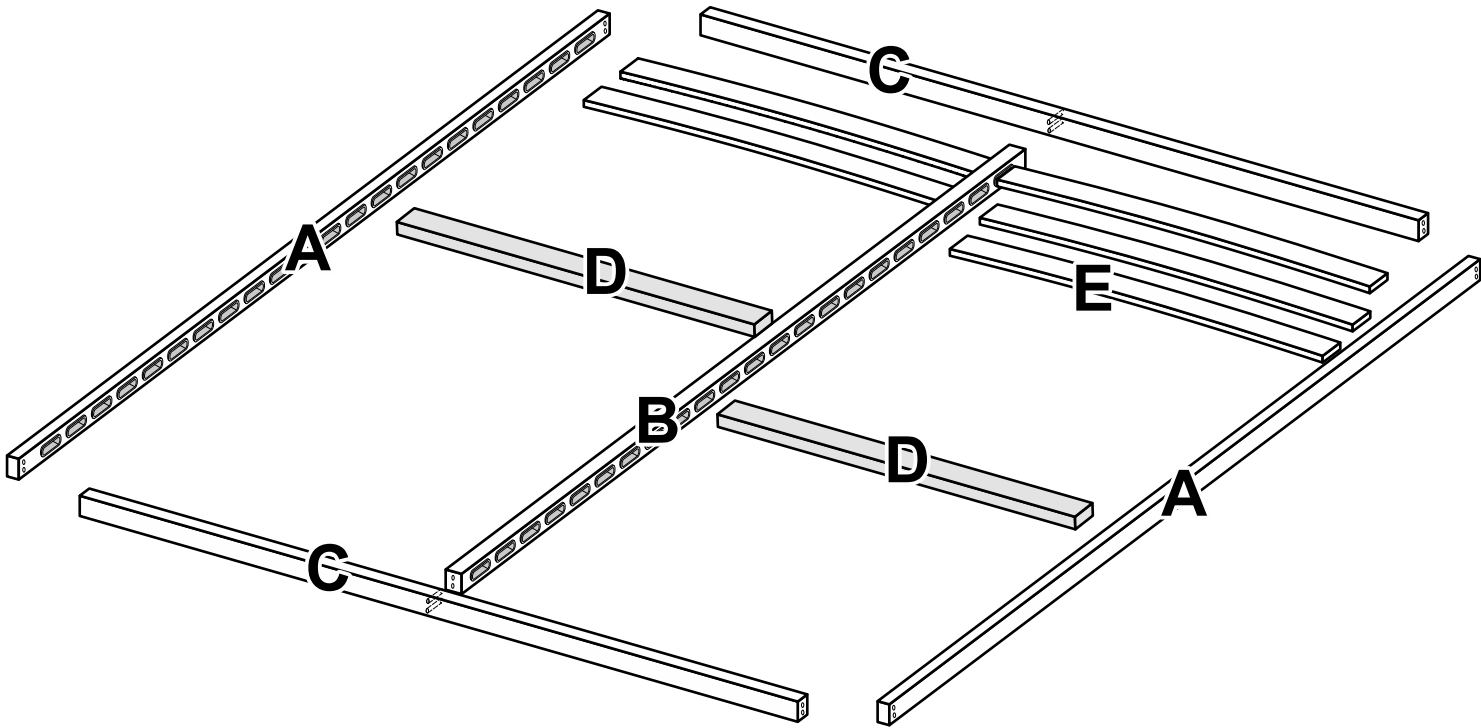
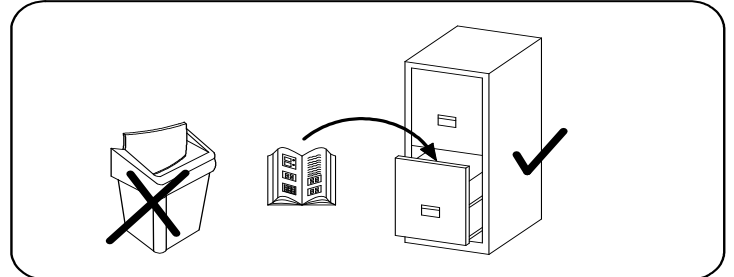
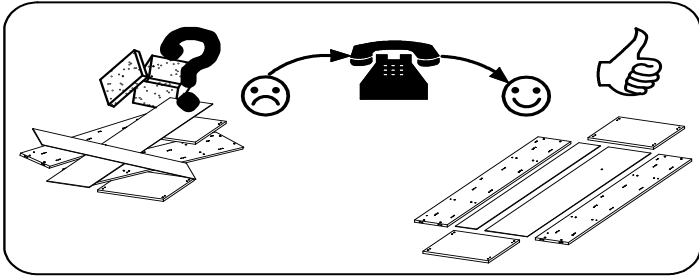
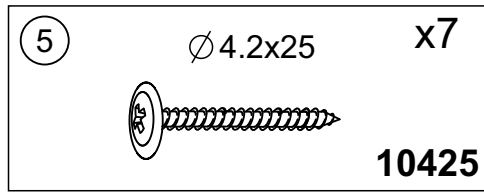
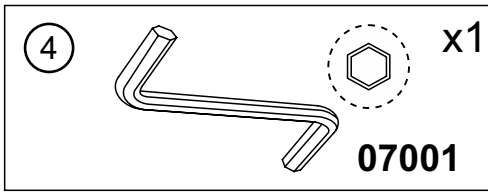
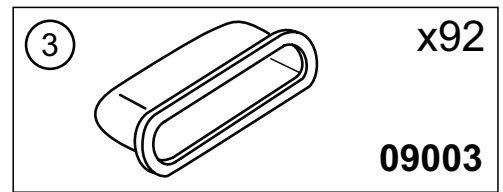
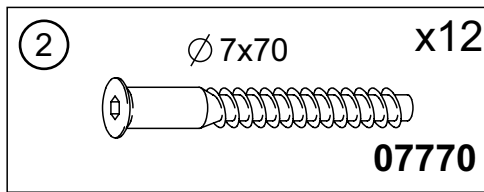
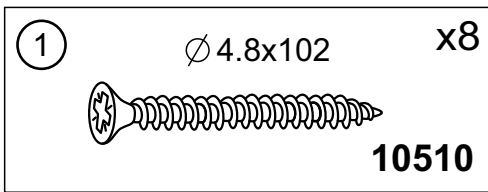

**1,6 m**

- A** - 2000 x 60 x 30 - x 2
- B** - 1940 x 60 x 50 - x 1
- C** - 1540 x 60 x 30 - x 1
- D** - 745 x 60 x 30 - x 1
- E** - 780 x 50 x 5 - x 46

**1,8 m**

- A** - 2000 x 60 x 30 - x 2
- B** - 1940 x 60 x 50 - x 1
- C** - 1740 x 60 x 30 - x 2
- D** - 845 x 60 x 30 - x 2
- E** - 880 x 50 x 5 - x 46

