

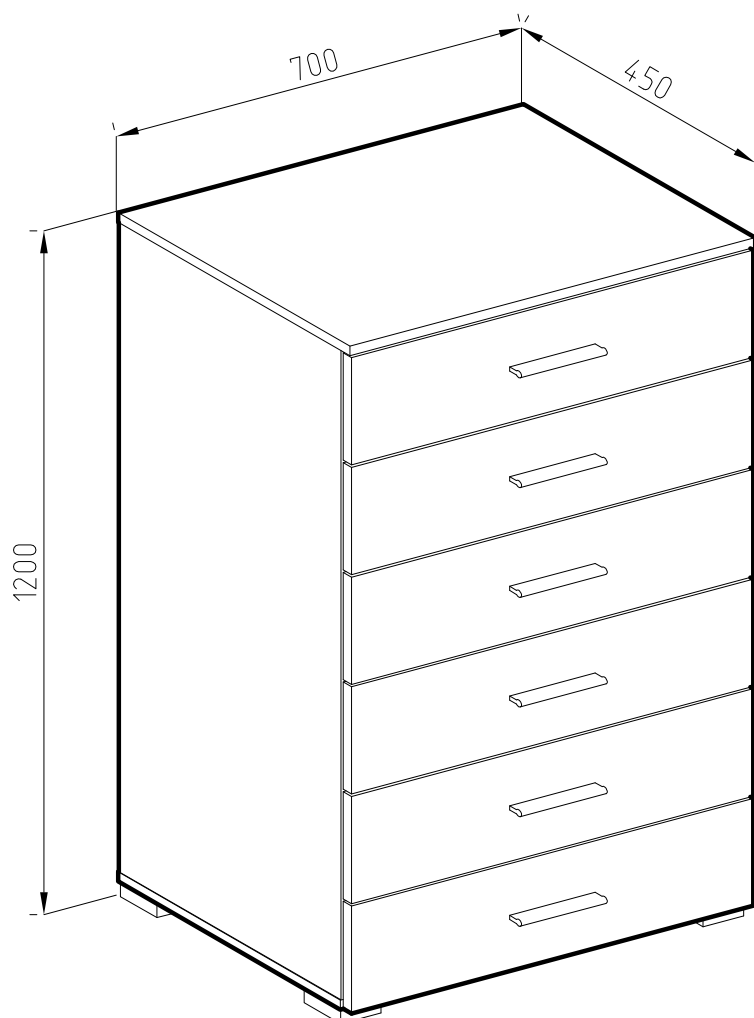

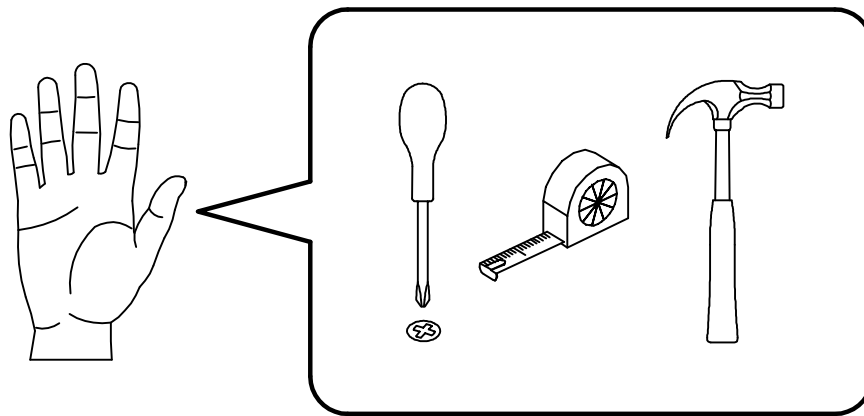







# ROMBO

## CHEST OF DRAWERS 6D

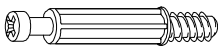
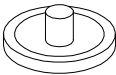

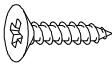
**S.A.**

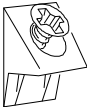
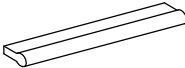
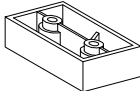
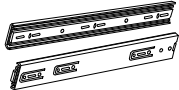
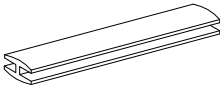

 <b>A1</b> 8*30mm x34	 <b>B</b> $\phi$ 12mm x16	 <b>B1</b> 6,3*50mm x16
 <b>C1</b> 6*43mm x18	 <b>D</b> $\phi$ 20mm x18	 <b>D1</b> 15/16 x18
 <b>E5</b> 3,5*16mm x48	 <b>E12</b> 4*20mm x8	 <b>E13</b> 4*25mm x12
 <b>H2</b> x12	 <b>I9</b> x6	 <b>K19</b> 20x40x60 x4
 <b>M2</b> 400mm x6	 <b>P10</b> L-1149 x1	 <b>R3</b> 1.4*25mm 30g
 <b>R4</b> N°4 x1		

№	a*b	x	№	a*b	x
1R	1150x428	1	6R	400x100	6
1L	1150x428	1	6L	400x100	6
2	700x446	1	7	694x190	1
3	700x428	1	8	694x190	5
4	666x100	1	9	617x393	6
5	608x100	6	10	1178x346	2

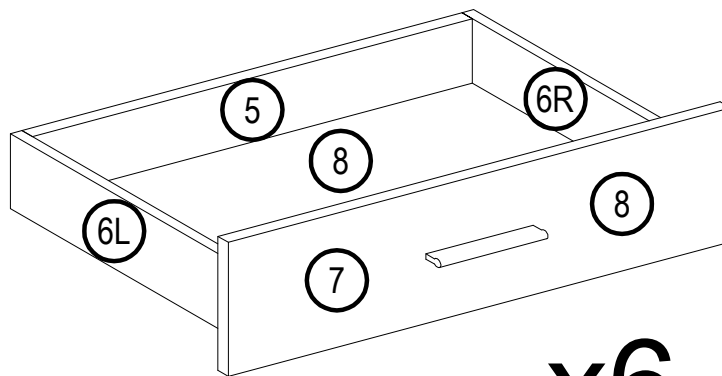

**x6**

