

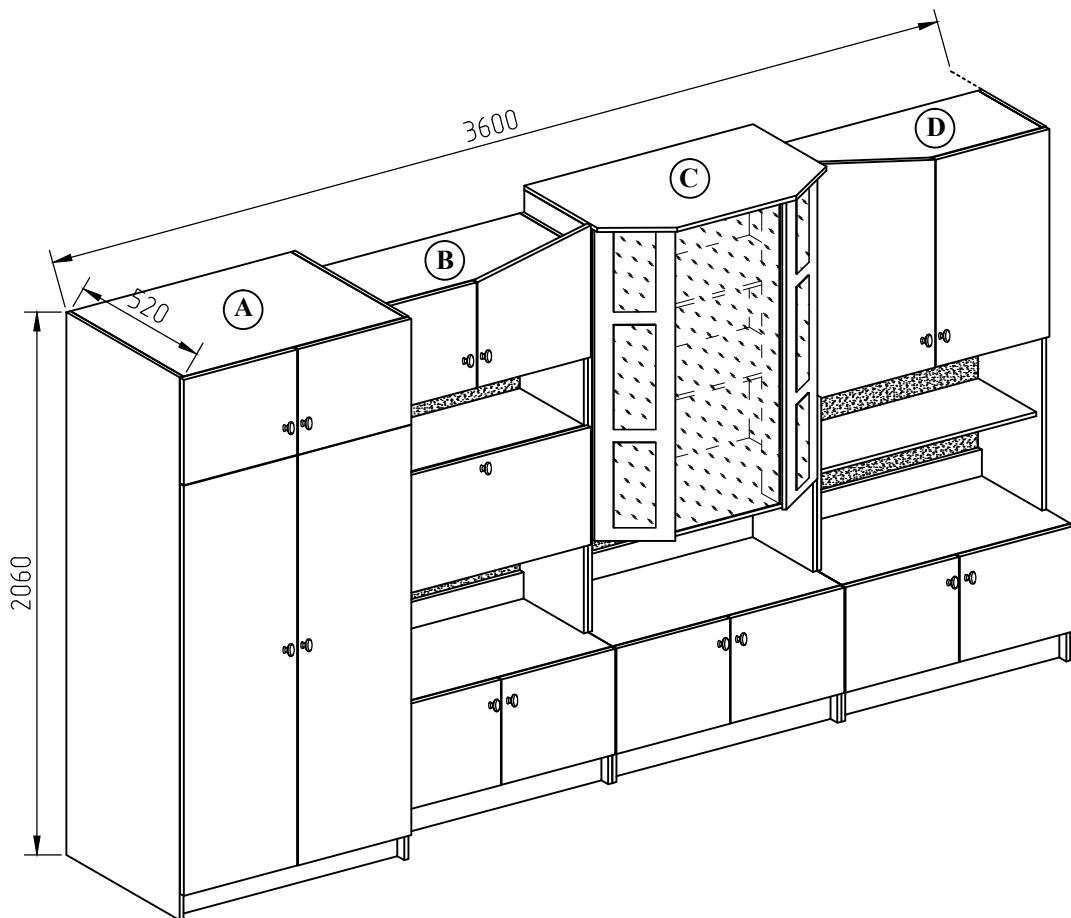

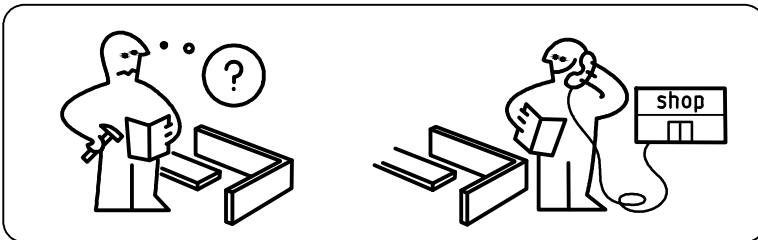

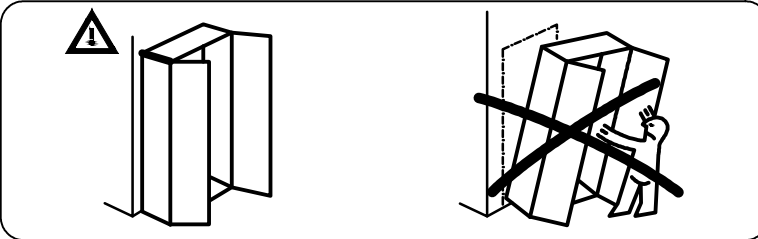

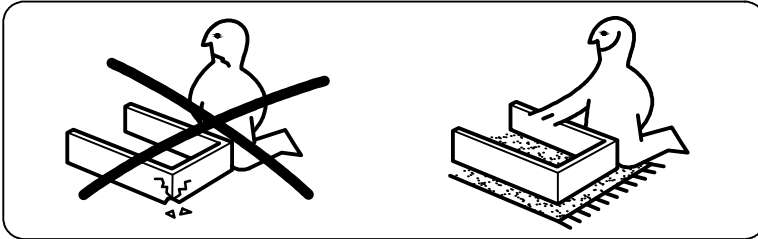

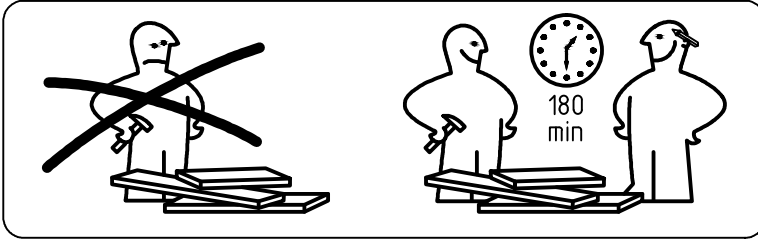
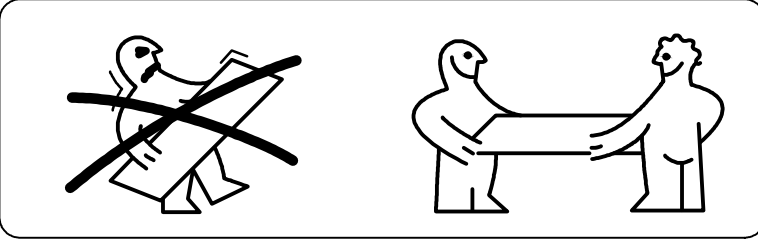
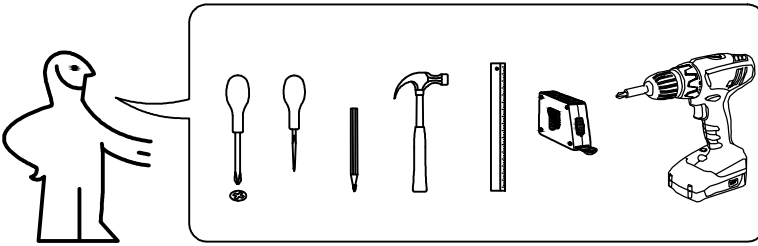

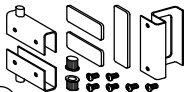
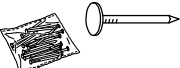







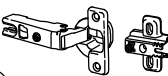

OSCAR



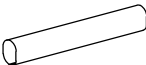

 <p>(Y1) x2</p>	 <p>(Y2) L- 1500mm x1</p>	 <p>(L9) x1</p>
 <p>(R3) 1.4*25mm 0.100kg</p>	 <p>(B) x32</p>	 <p>(R4) Nº4 x1</p>
 <p>(I1) x15</p>	 <p>(B1) 6,3*50mm x70</p>	 <p>(V4) x1</p>
 <p>(K1) x16</p>	 <p>(N4) R + L x2</p>	 <p>(L1) x32</p>
 <p>(J1) 5*16mm x16</p>	 <p>(E9) 4*16mm x82</p>	 <p>(E16) 4,5*30mm x15</p>
 <p>(E3) 3*15mm x13</p>	 <p>(E4) 3*20mm x8</p>	 <p>(F5) 6,3*13mm x64</p>
 <p>(P5) L-860mm x1</p>	 <p>(P6) x2</p>	 <p>(S10) 50x9x0,5 x6</p>
 <p>(A1) 8*30mm x92</p>	 <p>(R1) x1</p>	

	$a*b$	x
	Ⓐ	
1	2060x496	x2
2	867x496	x3
3	867x100	x1
4	400x446	x2
5	1556x446	x2
6	406x896	x1
7	1550x896	x1
8	L-866	x1

	$a*b$	x
	Ⓒ	
1	1538x280	x2
2	504x386	x2
3	867x386	x1
4	900x426	x1
5	867x254	x2
6	867x386	x1
7	900x430	x1
8	1204x234	x2
9	867x100	x1
10	867x100	x1
11	1187x80	x2
12	400x446	x2
13	896x1208	x1
14	896x265	x1
15	896x416	x1
16	1177x427	x1
17	340x100	x6

	$a*b$	x
	Ⓑ	
1	1454x280	x2
2	504x386	x2
3	867x280	x4
4	867x386	x1
5	900x426	x1
6	867x100	x1
7	400x446	x3
8	446x894	x1
9	500x446	x1
10		
11	896x394	x1
12	896x416	x1
13	896x278	x1
14	896x436	x1
15	896x265	x1

	$a*b$	x
	Ⓓ	
1	1454x280	x2
2	504x386	x2
3	867x280	x2
4	867x386	x1
5	900x426	x1
6	867x254	x2
7	867x100	x1
8	867x100	x1
9	788x446	x1
10	888x446	x1
11	400x446	x2
12	896x416	x1
13	896x782	x1
14	896x590	x1

