

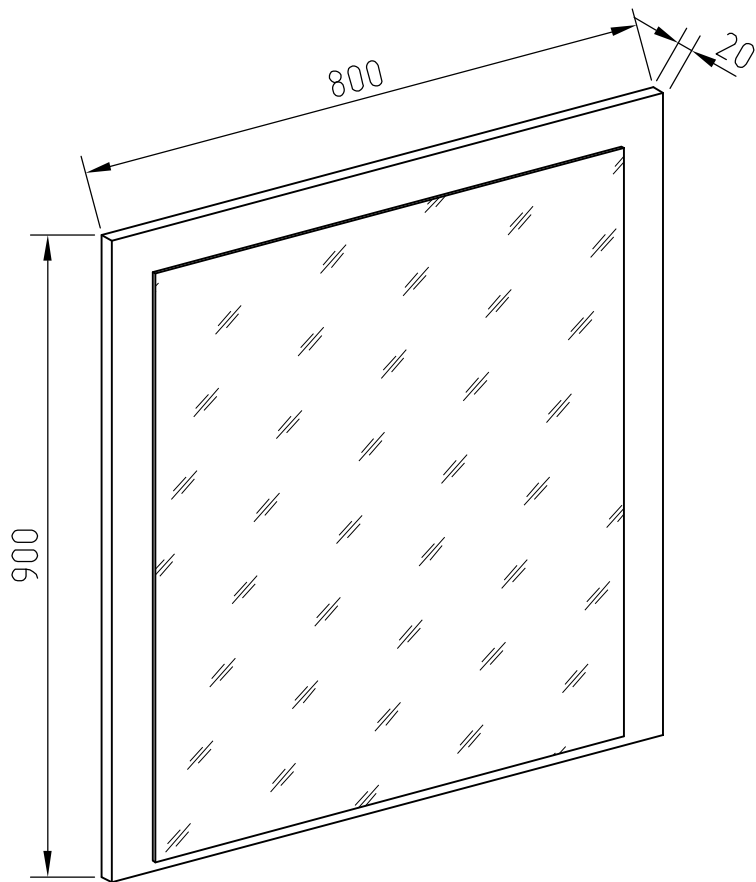

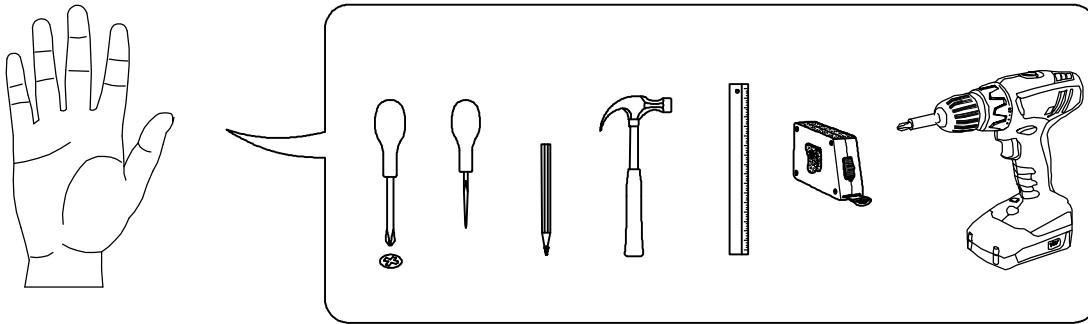



# **RIO**

## **MIRROR**



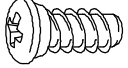
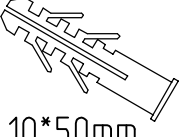



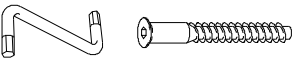

 <b>(E21)</b> 6*60mm x2	 <b>(F1)</b> 5,0*10,5mm x4	 <b>(F4)</b> 6,3*13mm x2
 <b>(H6)</b> 10*50mm x2	 <b>(H14)</b> x2	

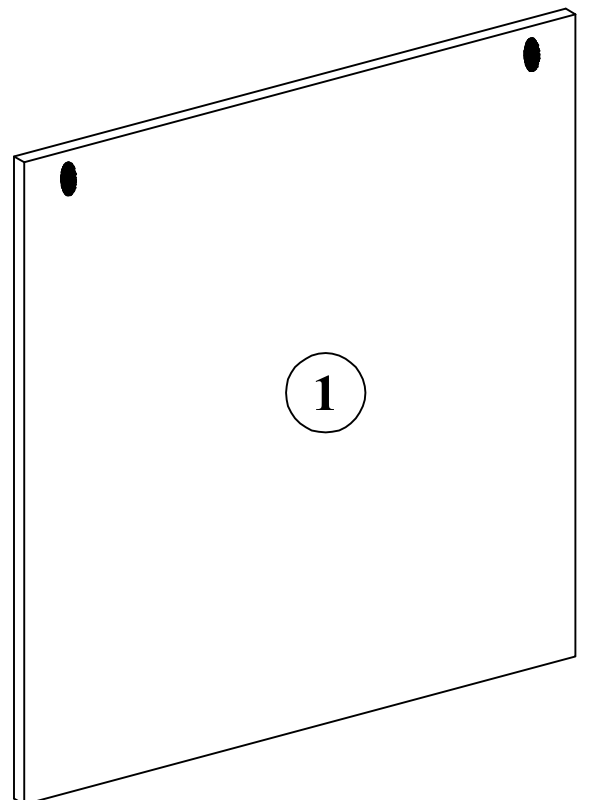
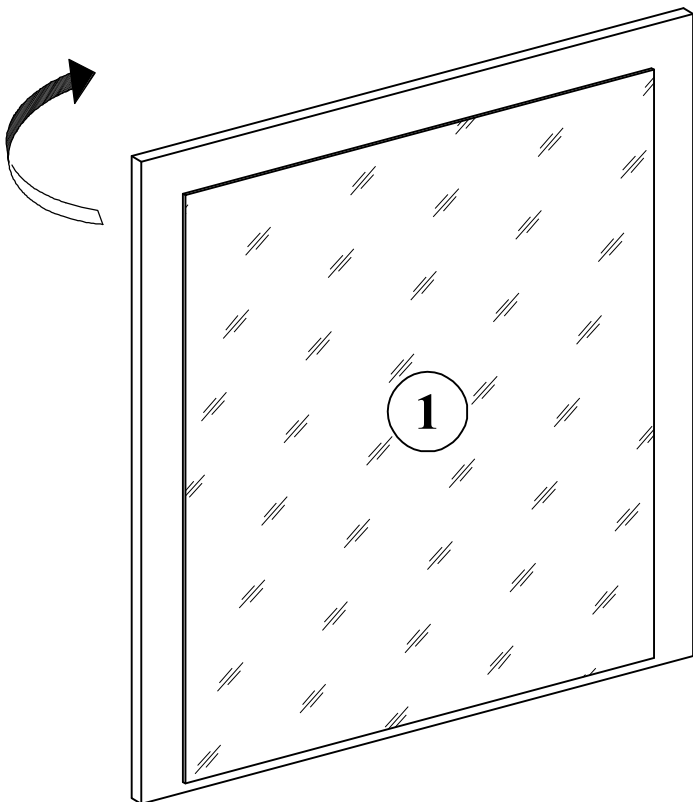
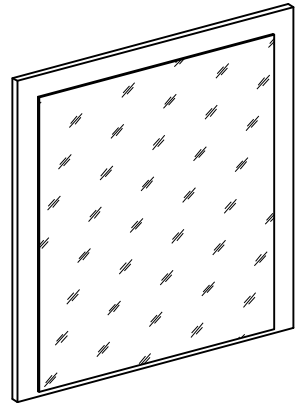
No	a*b	x	N°→...
1	800x900	x1	1/1
		x1	1/1

**RIO**  
**MIRROR**

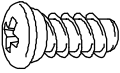

**RIO**  
**MIRROR**

 (F1) 5,0*10,5mm x4	 (F4) 6,3*13mm x2	 (H14) x2
---	---	---

**1**

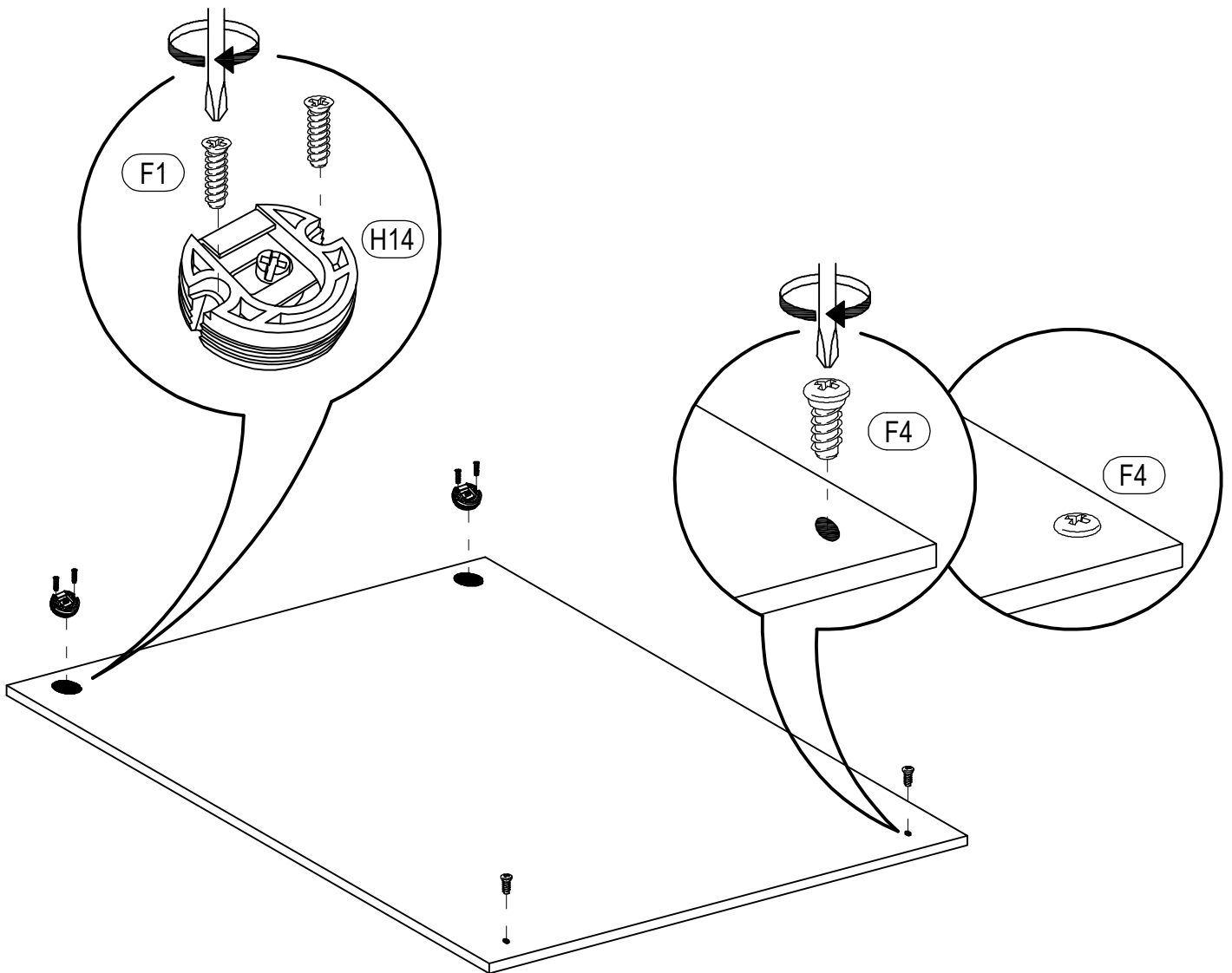

**2**

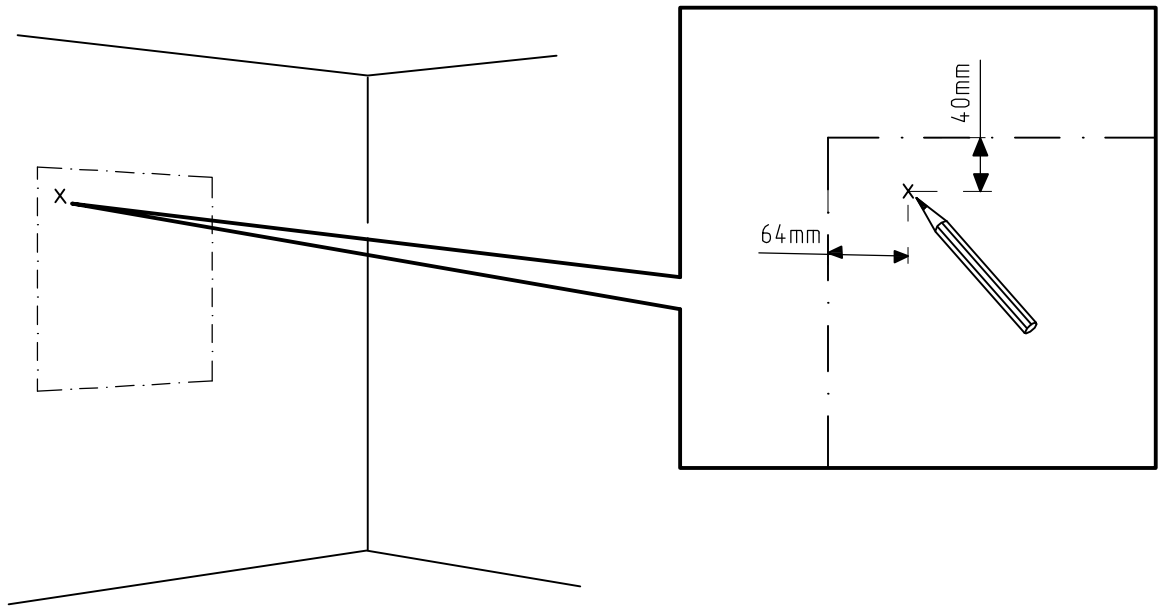

**3**

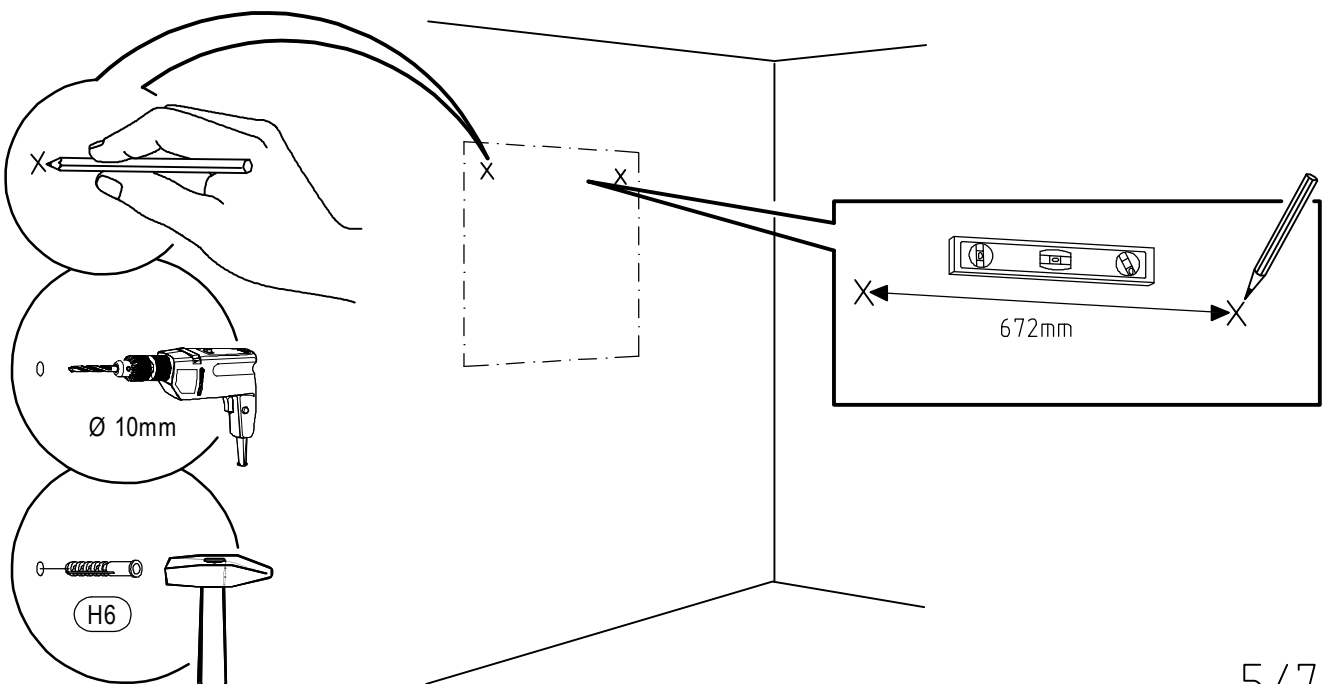
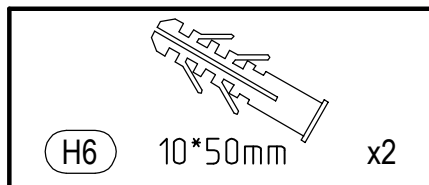

**4**

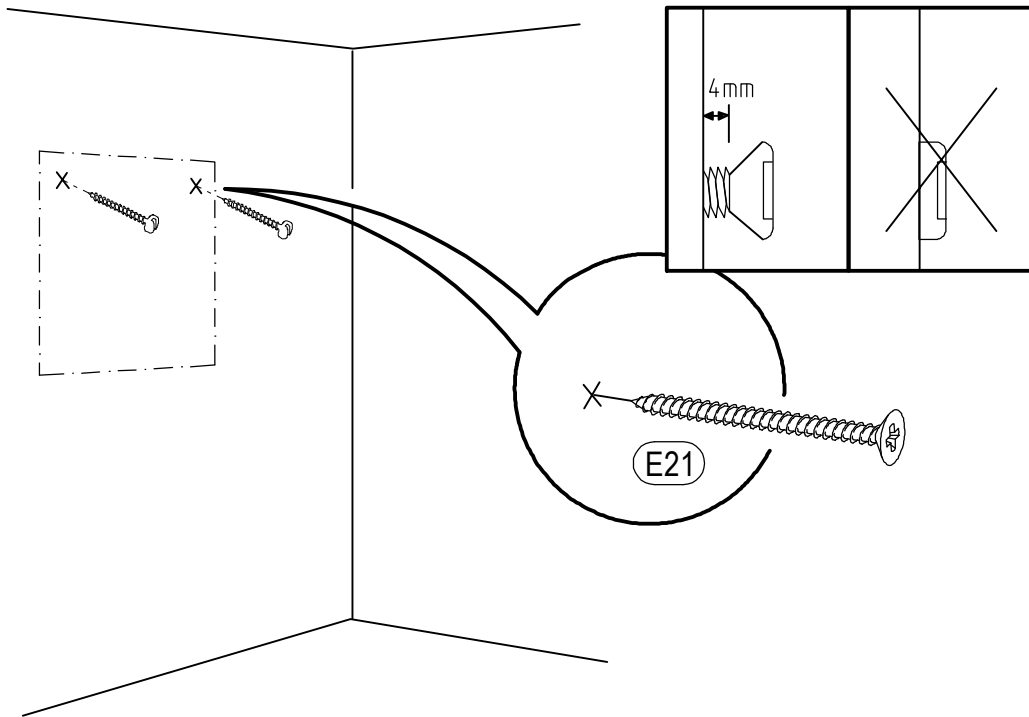
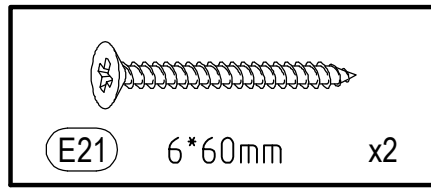

**5**

