

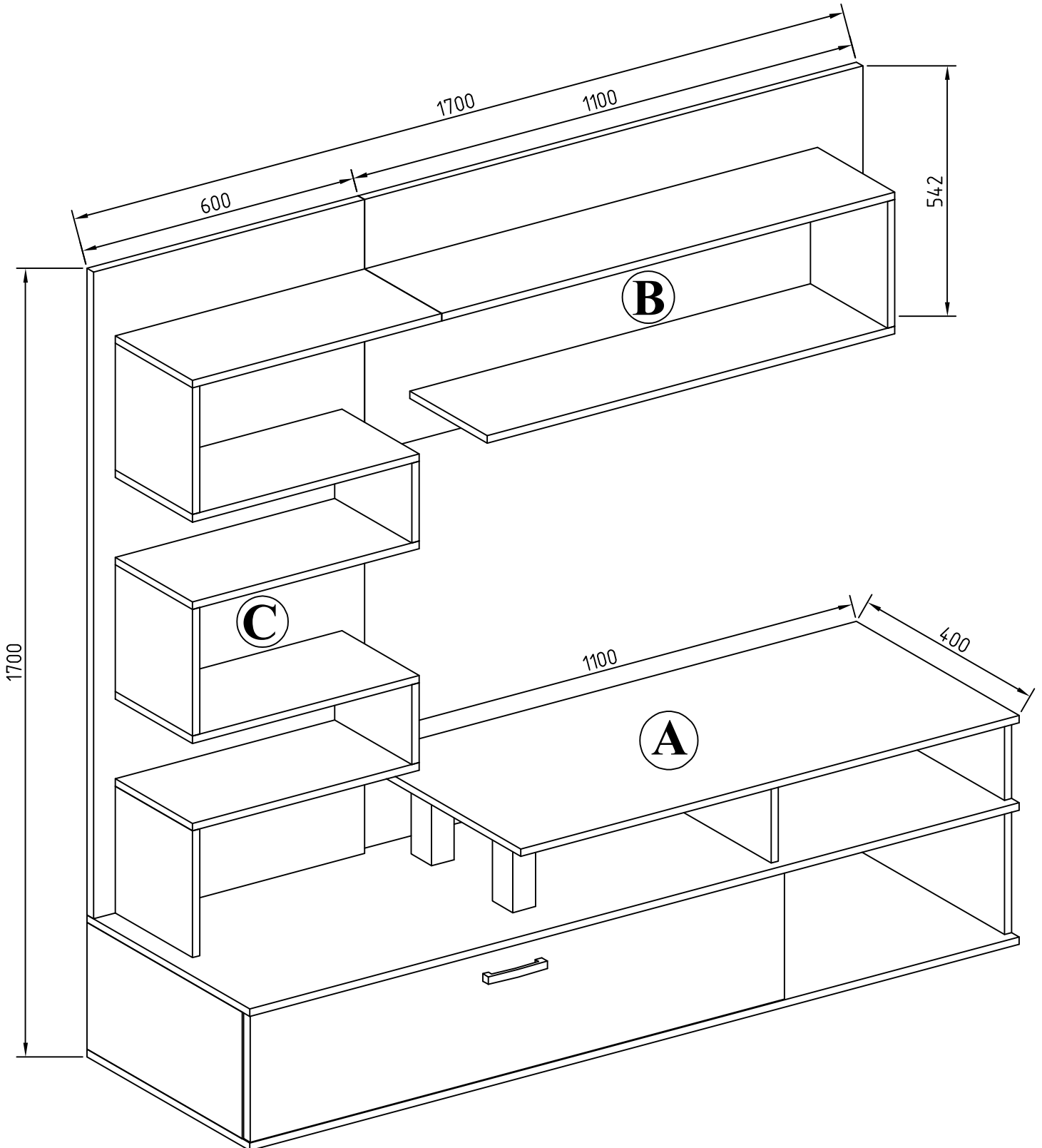

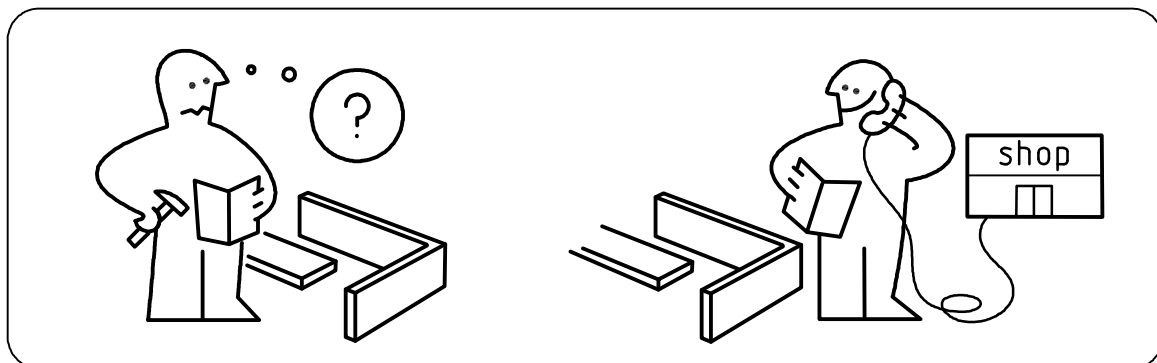

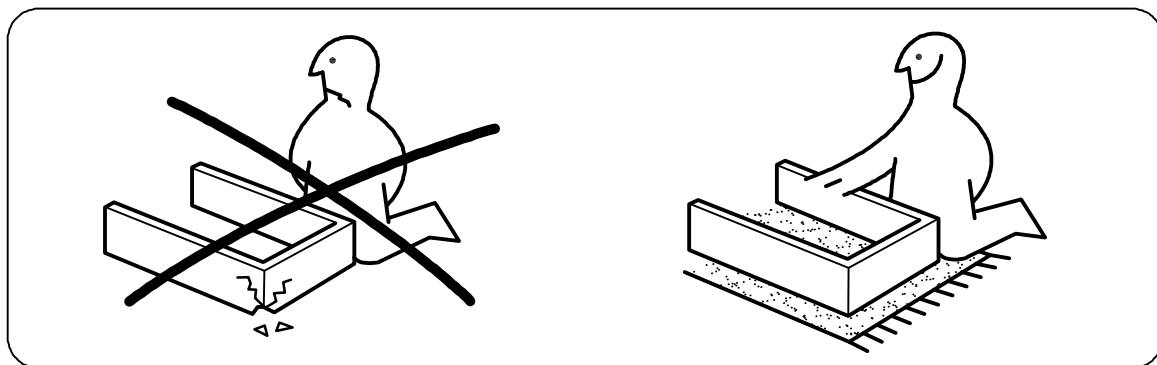

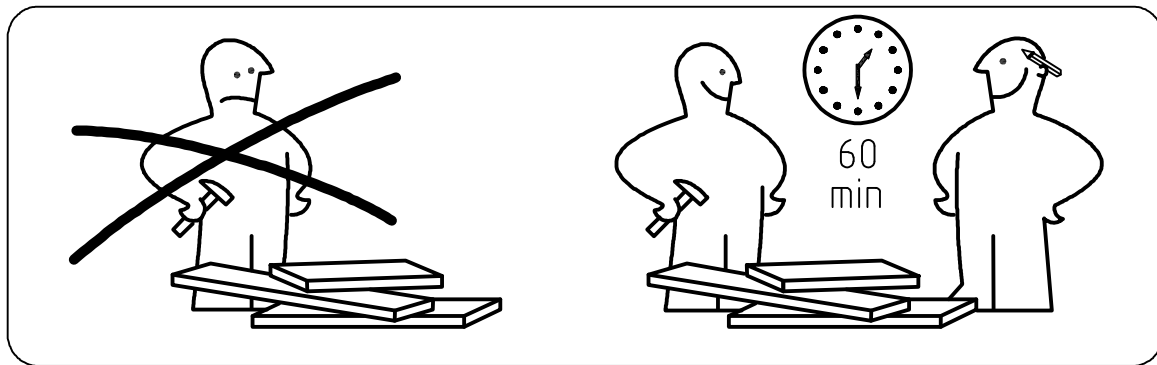

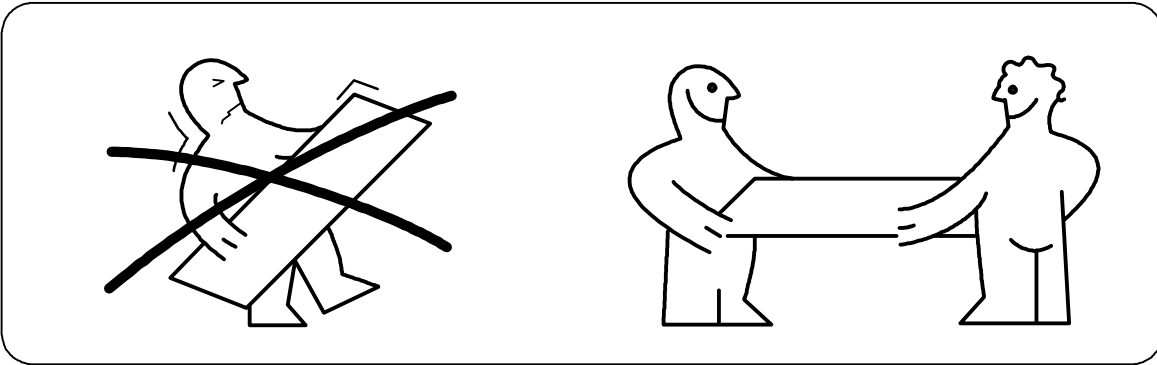
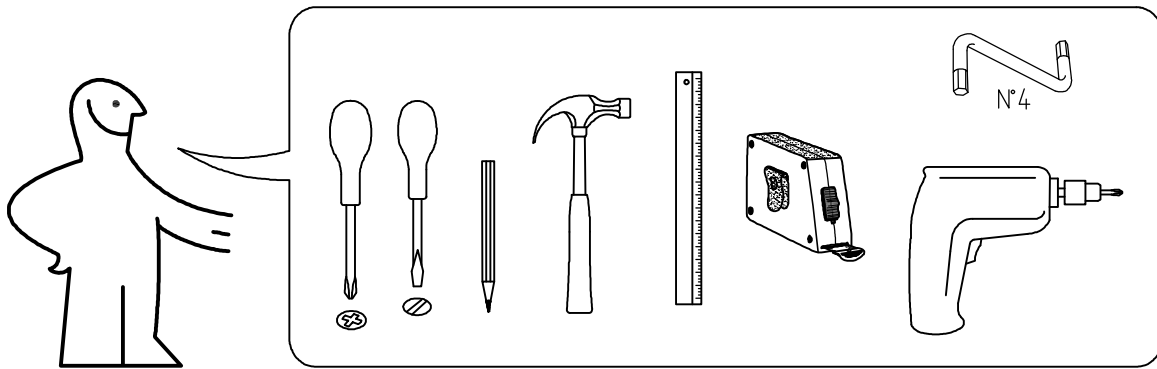



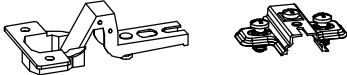



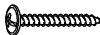

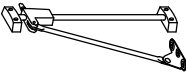
SIDNI



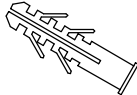

 C1 5*30mm x24	 D1 16mm x24	 D x24
 A1 8*30mm x28	 L3 x3	 E3 4*16mm x6
 F1 6,3*13mm x6	 l8 x1	 F1 3,5*27mm x2
 K5 x5	 N4 L+R x2	 E1 3*16mm x16
 E3 3*15mm x6	 B1 6,3*50mm x50	 B x50
 E5 3*20mm x8	 H6 8*50mm x4	 E15 4*60mm x4
	 R3 1.4*25mm 0.03kg	 S9 45x13x2 x4

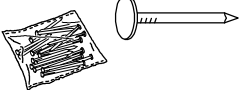
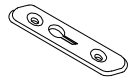
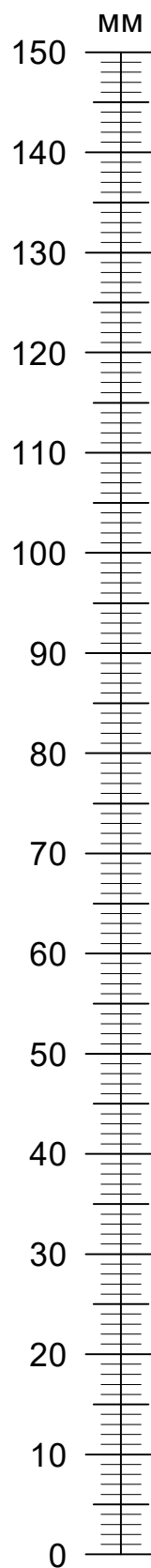

A

No	a*b	x
1	1100x400	1
2	1700x400	1
3	1700x382	1
4	170x382	2
5	270x382	4
6	1176x280	1
7	296x1177	1
8	L-170	2

B

No	a*b	x
1	542x1100	1
2	270x190	1
3	1000x190	1
4	900x190	1

C

No	a*b	x
1	1378x600	1
2	550x190	1
3	500x190	4
4	270x190	3
5	170x190	2

