



СВІТ МЕБЛІВ

# BASYA NEW

---



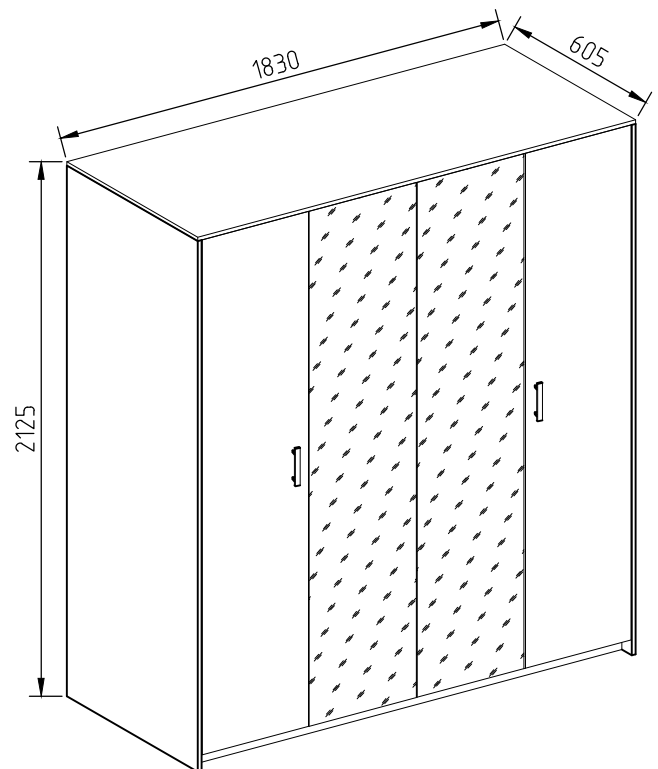
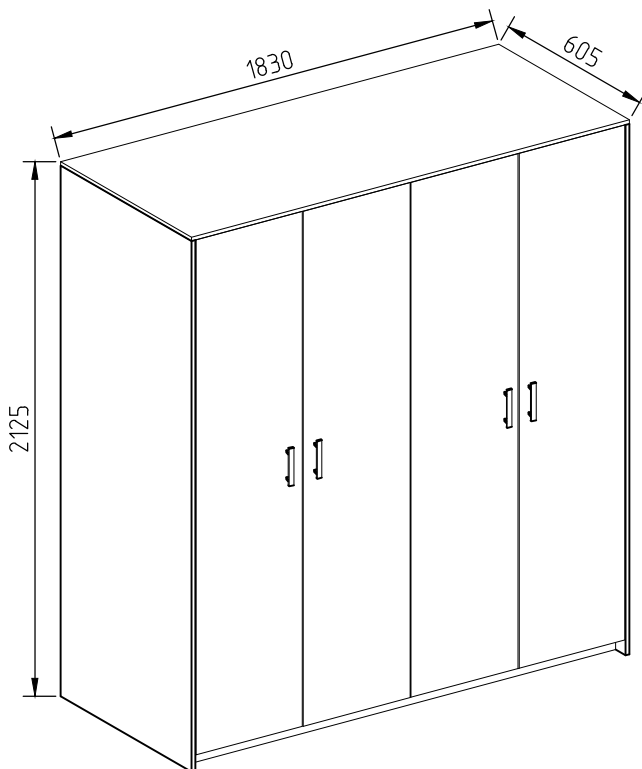



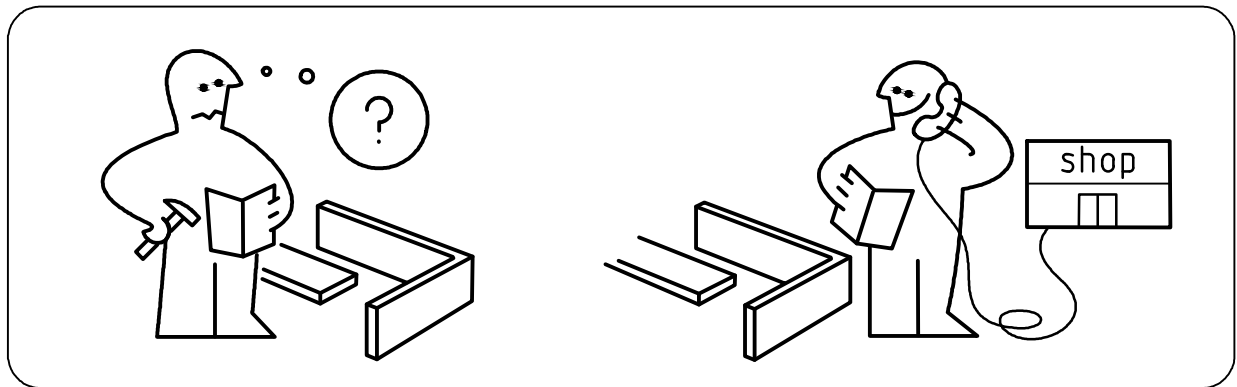
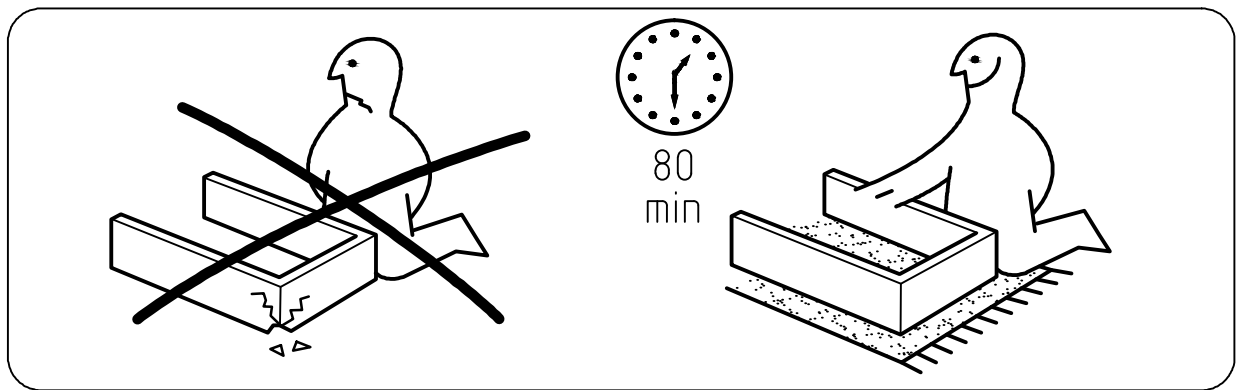
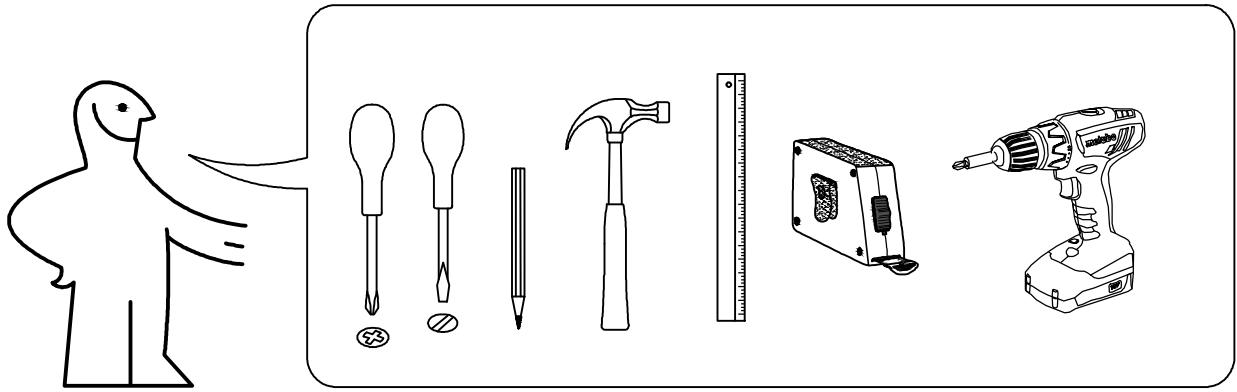





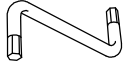



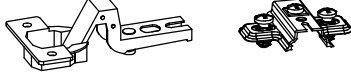
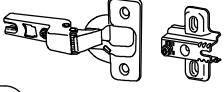

## WARDROBE 4D,4DM

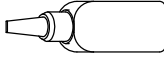

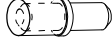
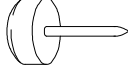
# BASYA NEW

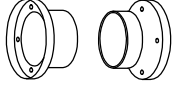

# BASYA NEW

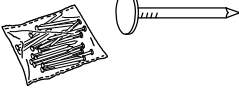
 <b>B1</b> 6,3*50mm x8	 <b>B</b> x8	 <b>P1</b> x1
 <b>C1</b> 5*30mm x20	 <b>D1</b> 16mm x20	 <b>D</b> x20
 <b>L3</b> x10	 <b>L2</b> x10	 <b>F2</b> 6,3*13mm x40
 <b>E10</b> 4*16mm x46	 <b>A1</b> 8*30mm x28	 <b>R1</b> x1
 <b>J1</b> x8	 <b>J4</b> x4	 <b>K1</b> x6
 <b>P1</b> d-25mm L-884 x1	 <b>P3</b> R-11M/25 x2	 <b>I8</b> x4
 <b>G6</b> M 4*25mm x8	 <b>H1</b> M 4 x8	 <b>L9</b> H 5MM x10
 <b>R3</b> 1.4*25mm 0.07kg		

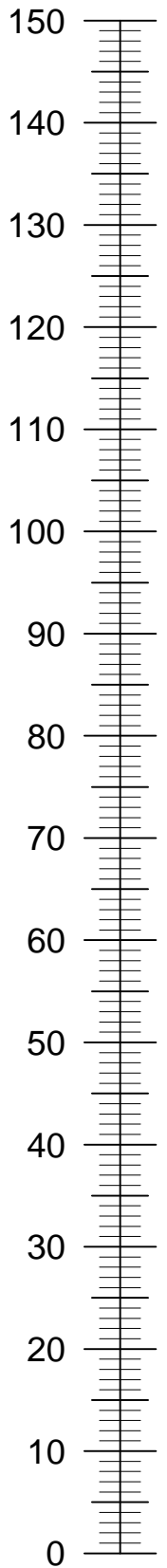

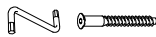

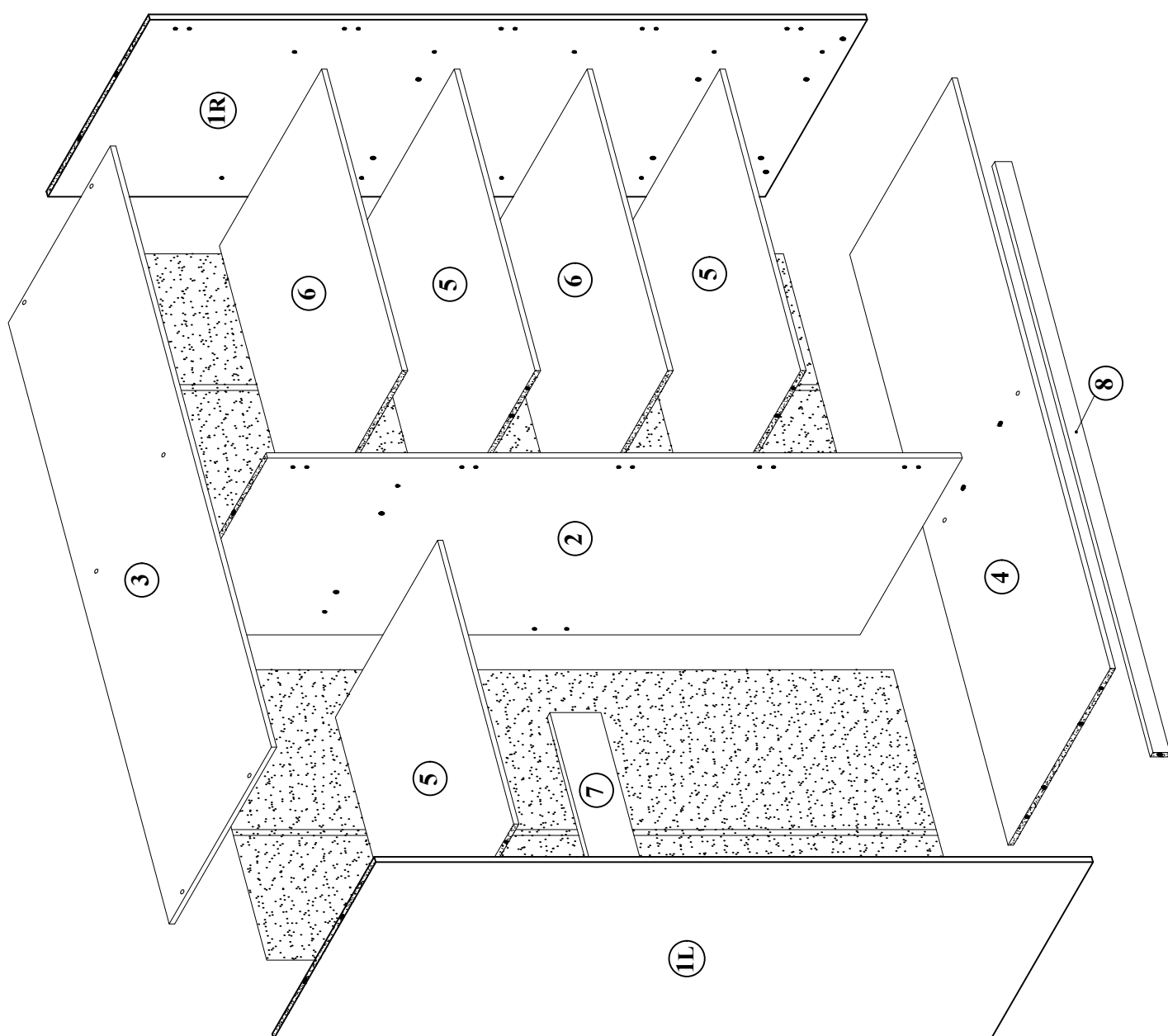
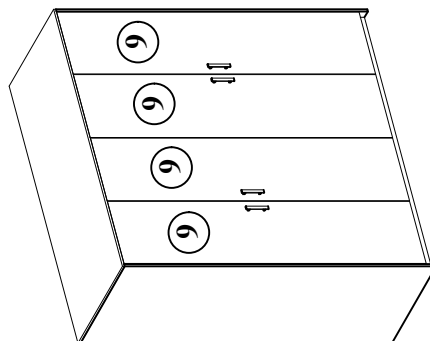
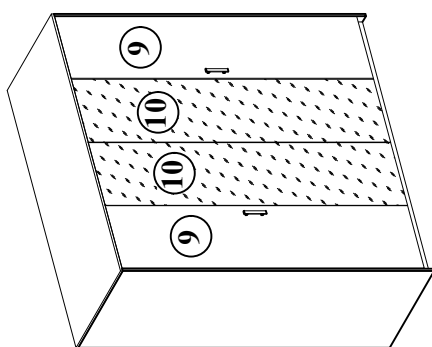

	a*b	x	N°→...		a*b	x	N°→...
1L+R	2107x600	2		8	1792x50	2	
2	2039x579	1		9	2050x443	4	
3	1828x600	1		10	2050x443	2	
4	1792x579	1		11	2071x455	4	
5	887x570	3					
6	887x570	2					
7	887x150	1					

# BASYA NEW







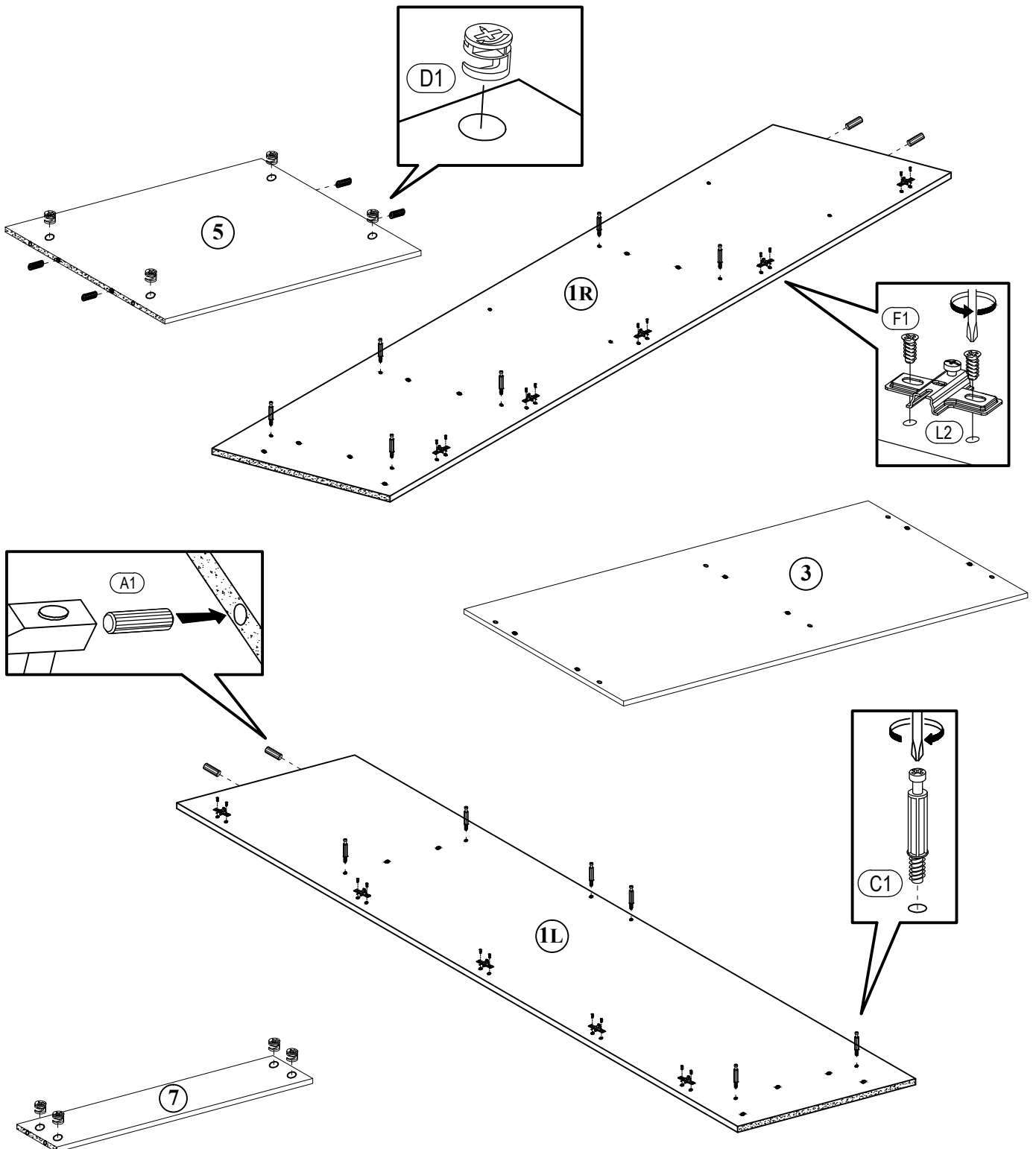

# 1

 C1 5*30mm x12	 D1 16mm x12	 A1 8*30mm x16
 x10	 F2 6,3*13mm x20	



# 2

 (C1) 5*30mm x8	 (D1) 16mm x4	 (A1) 8*30mm x12
 (L9) H 5mm x5	 x5	 (F2) 6,3*13mm x10

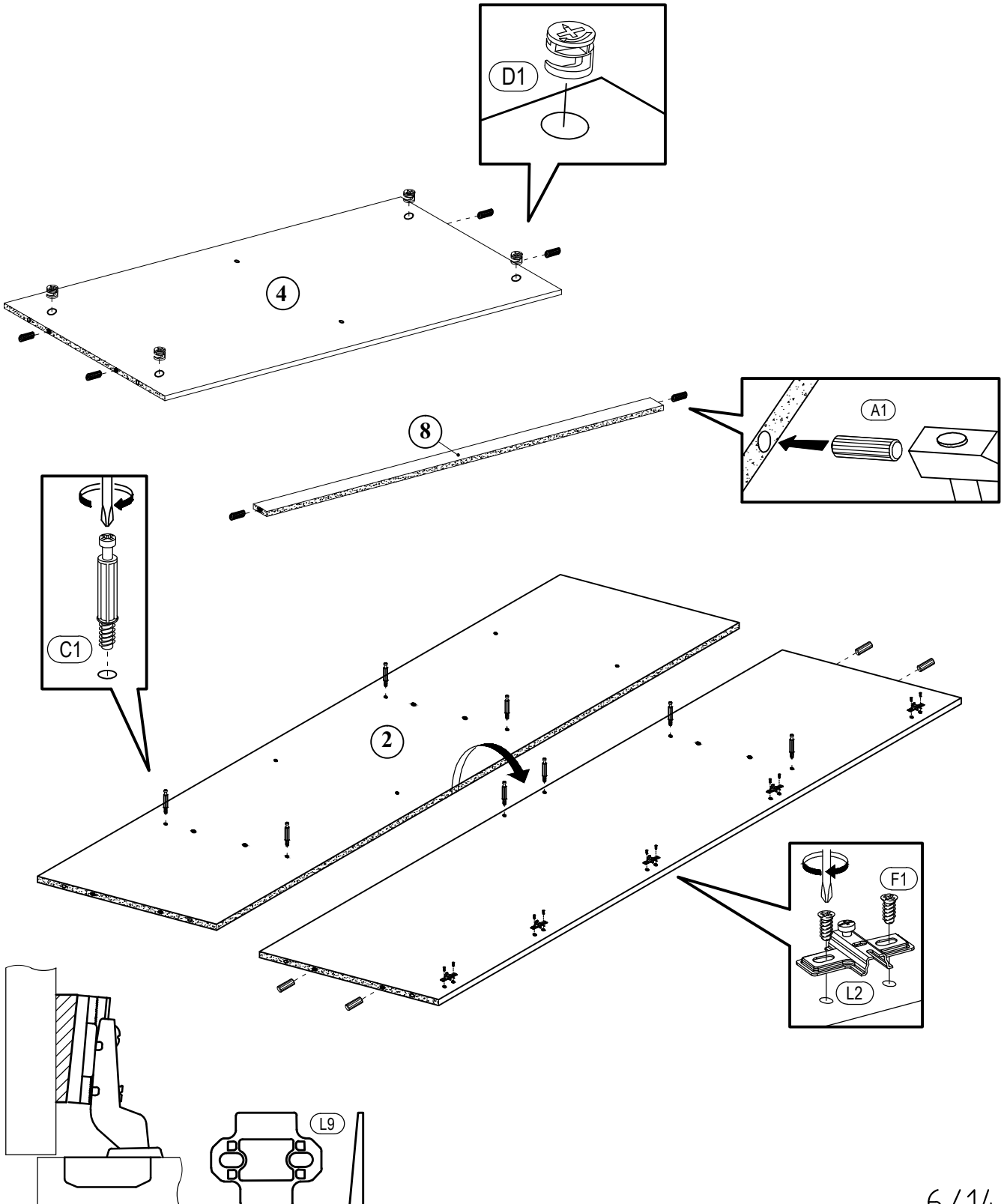

**3**

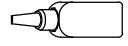
 (B1) 6,3*50mm x8	 (R1) x1
---	--

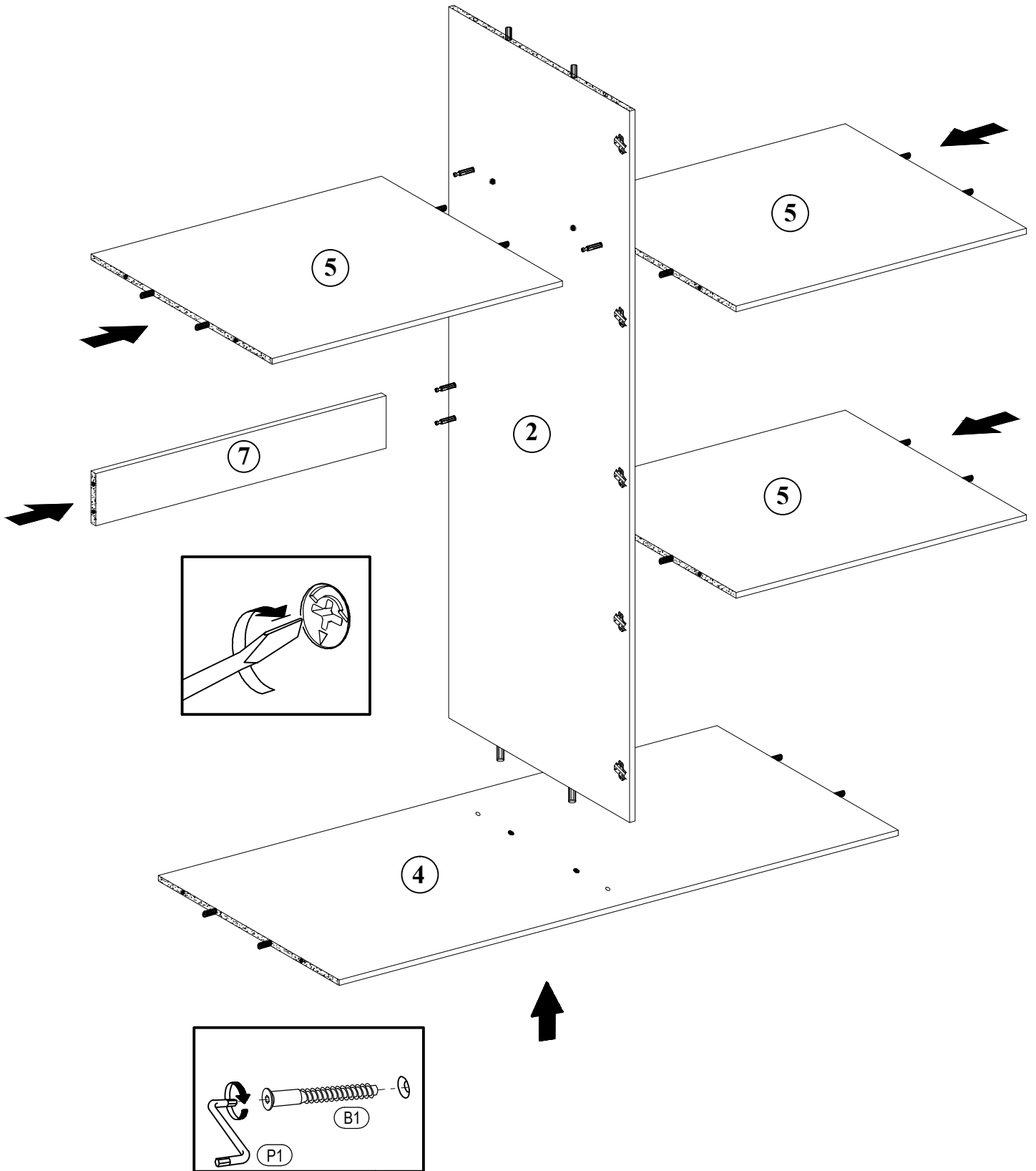

**4**

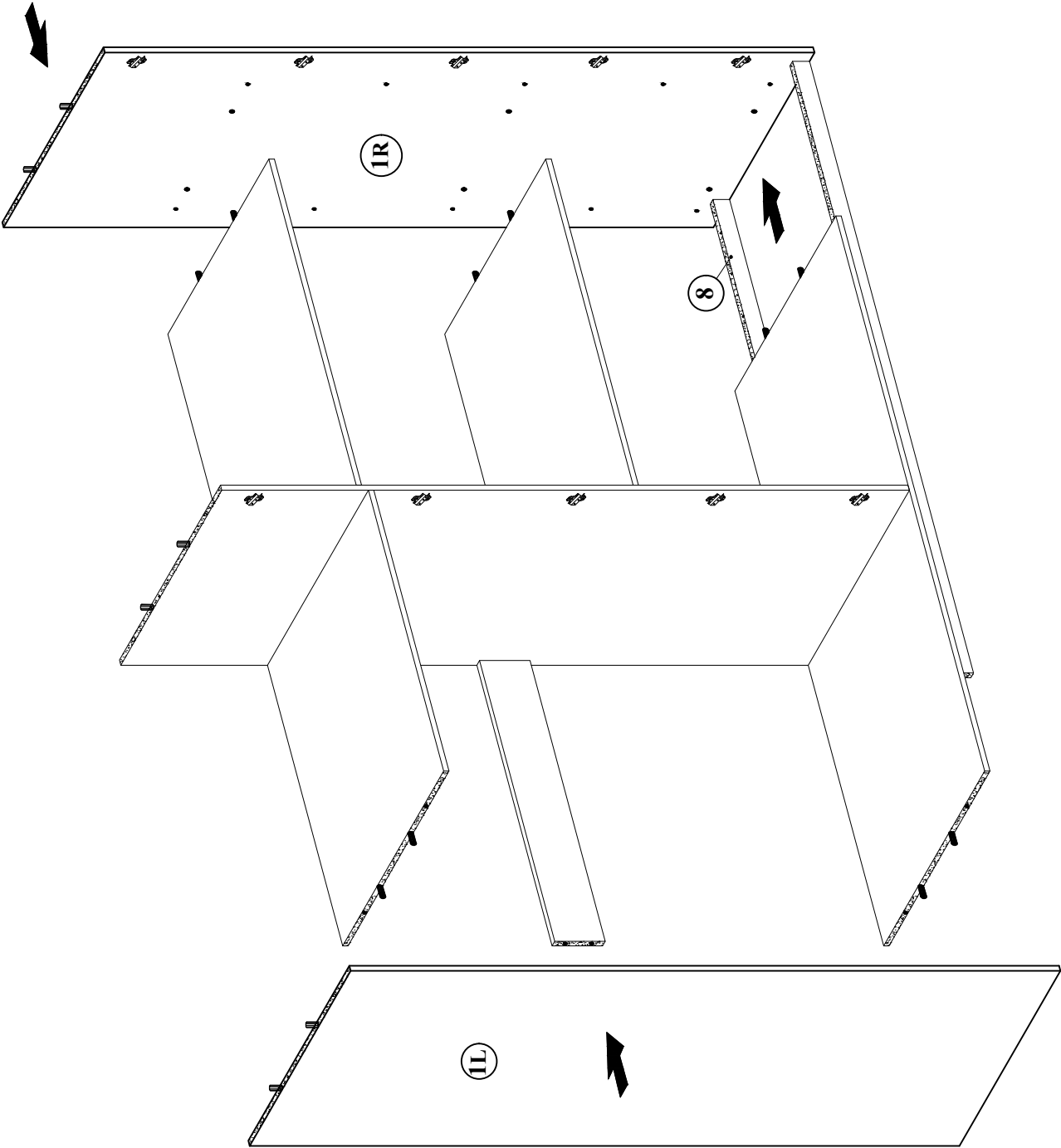
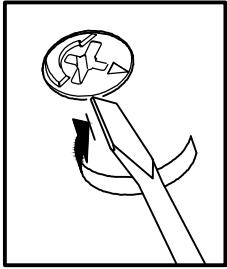





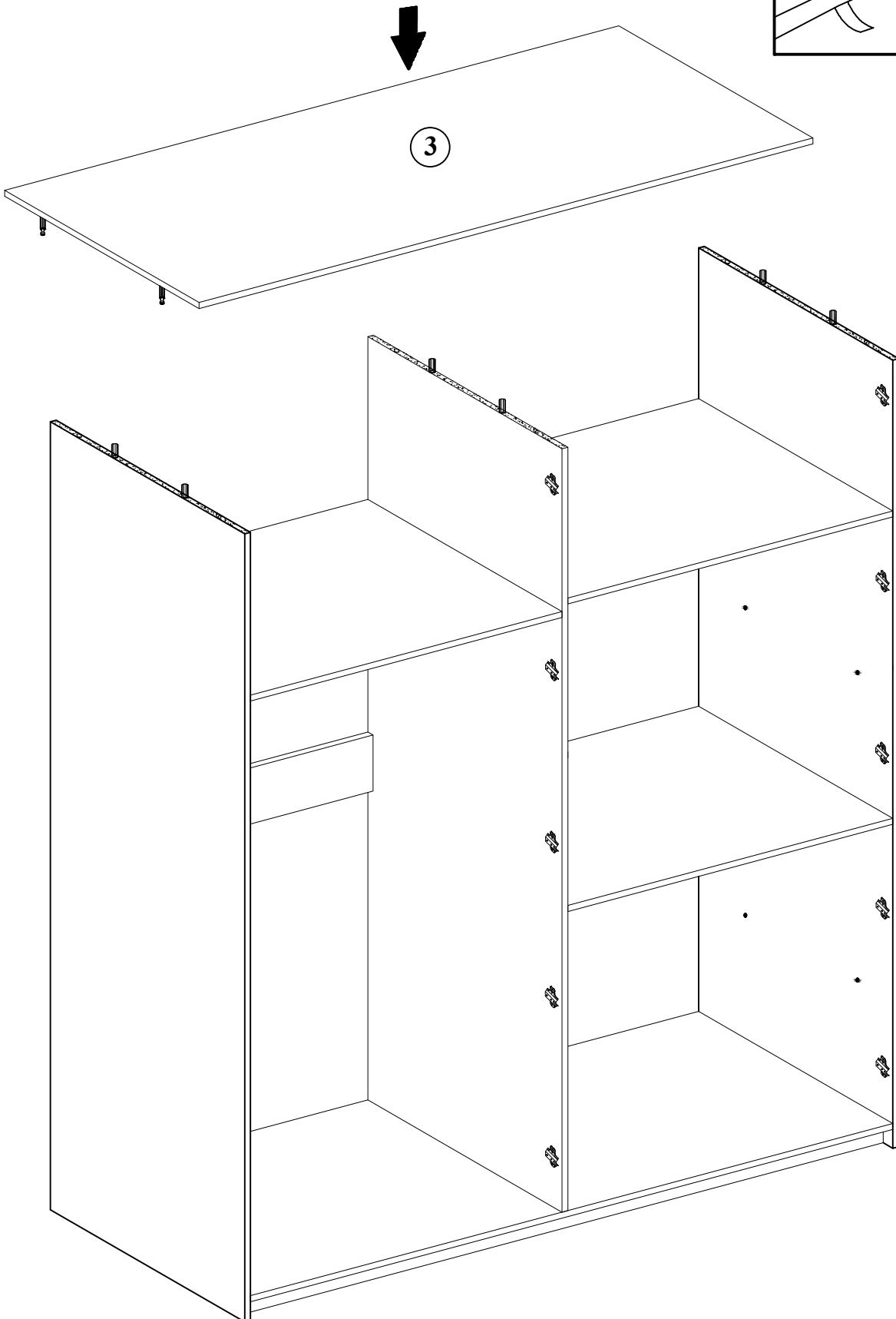
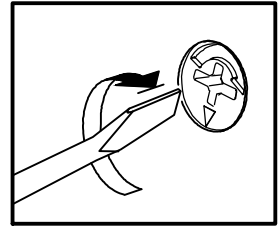

**5**



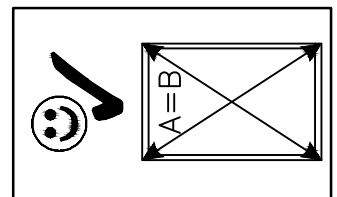
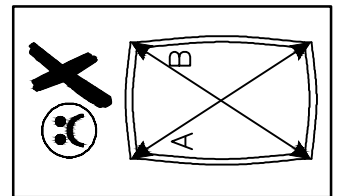
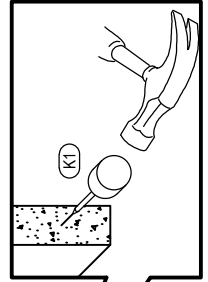
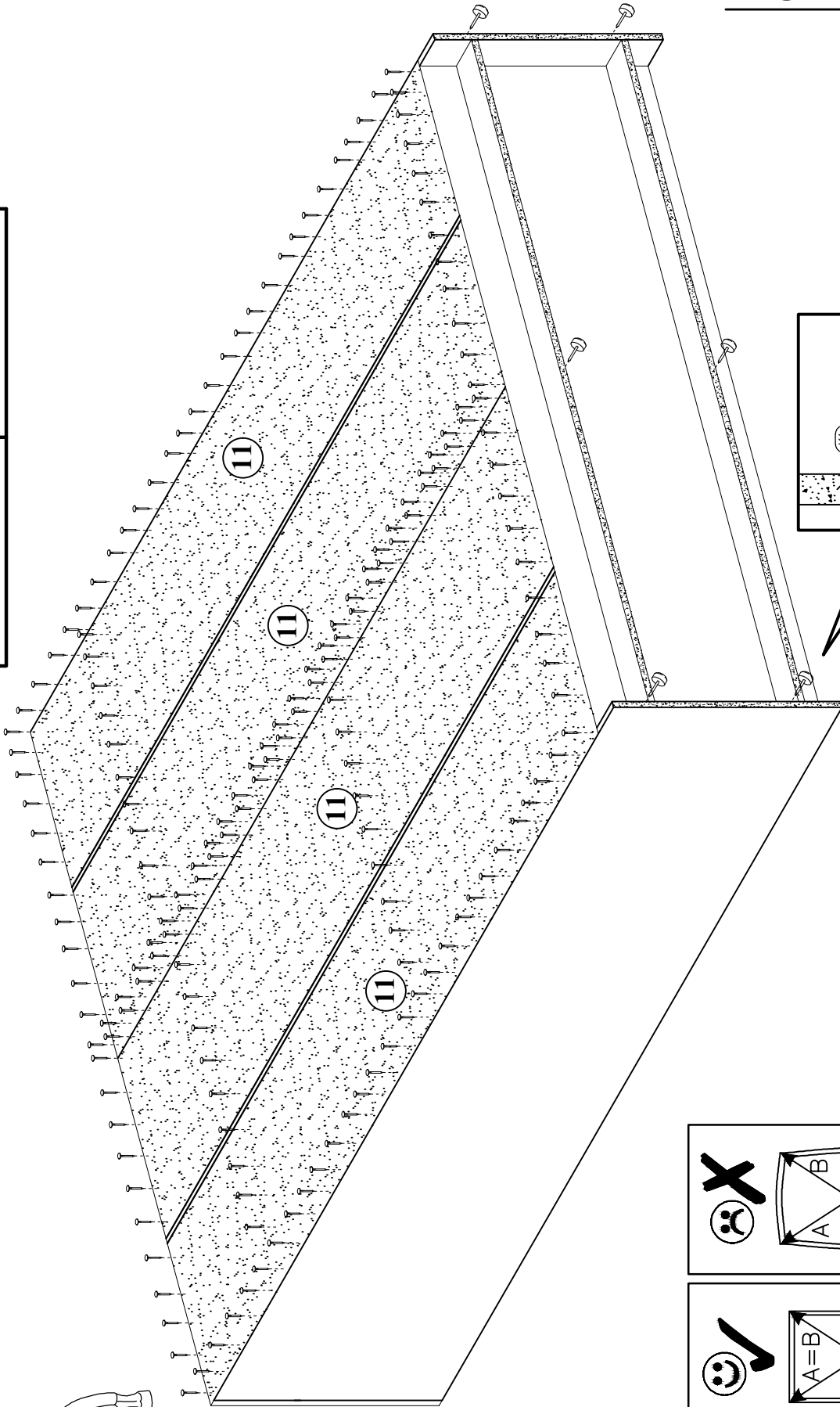

**6**

	x6
	(K1)
	0.07kg
	1.4*25mm
	(R3)



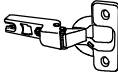

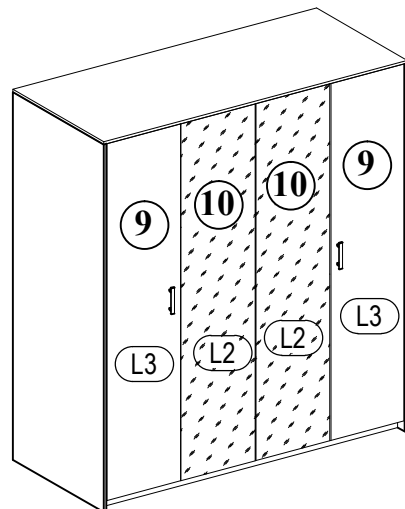
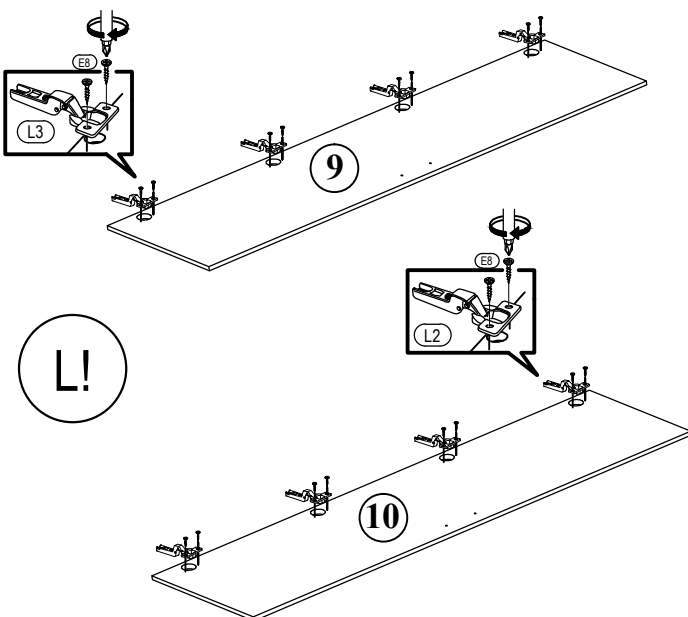
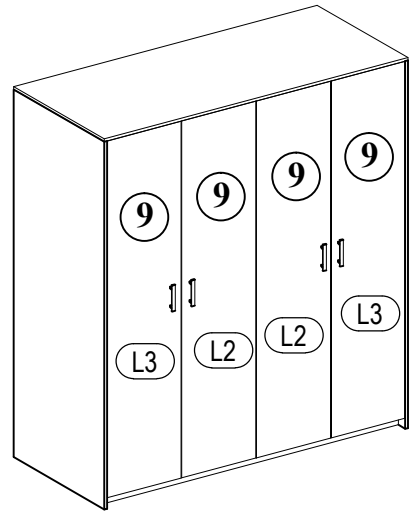
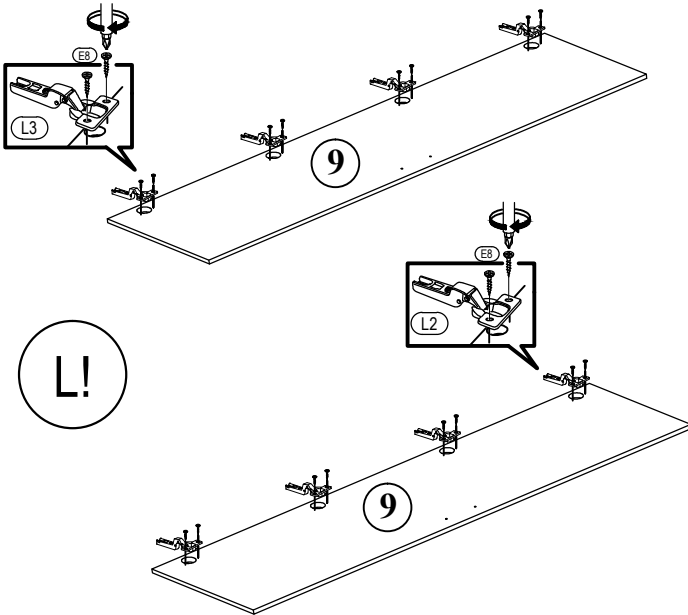

**7**

 L3	x10	 L2	x10	 E10	4*16mm	x40
---	-----	---	-----	--	--------	-----





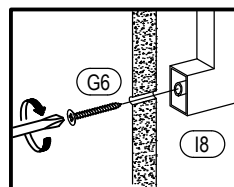
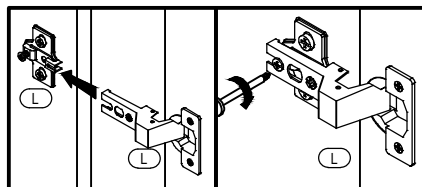
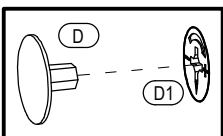
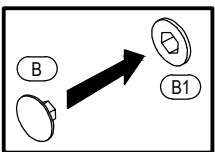
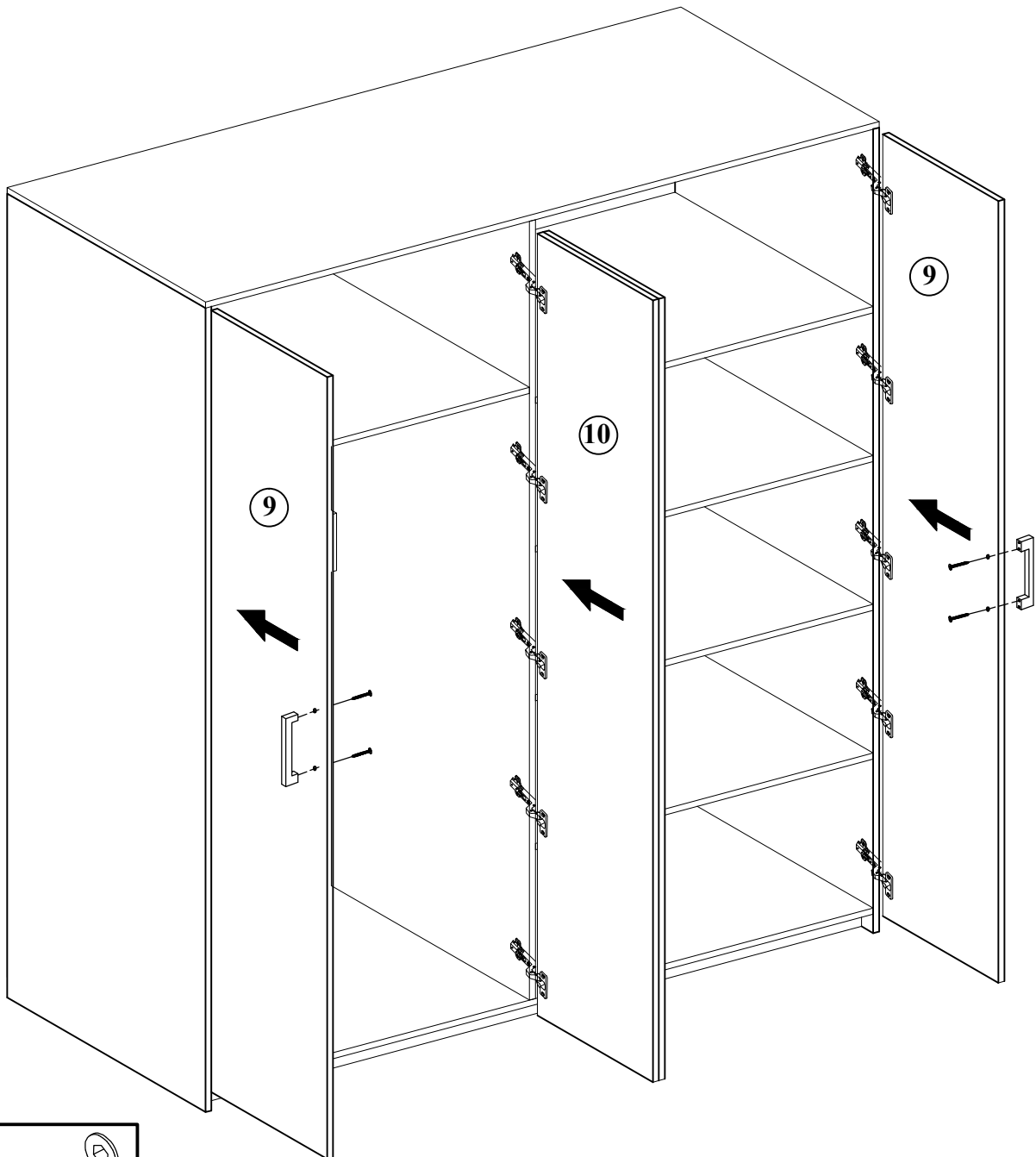

**8**

 I8 x4	 G6 M 4*25mm x8	 H1 M 4 x8
 D x20	 B x8	

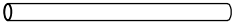
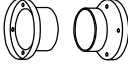

**9**

 P1 d-25mm L-884 x1	 P3 R-11M/25 x2	 E10 4*16mm x6
 J1 x8	 J4 x4	

