

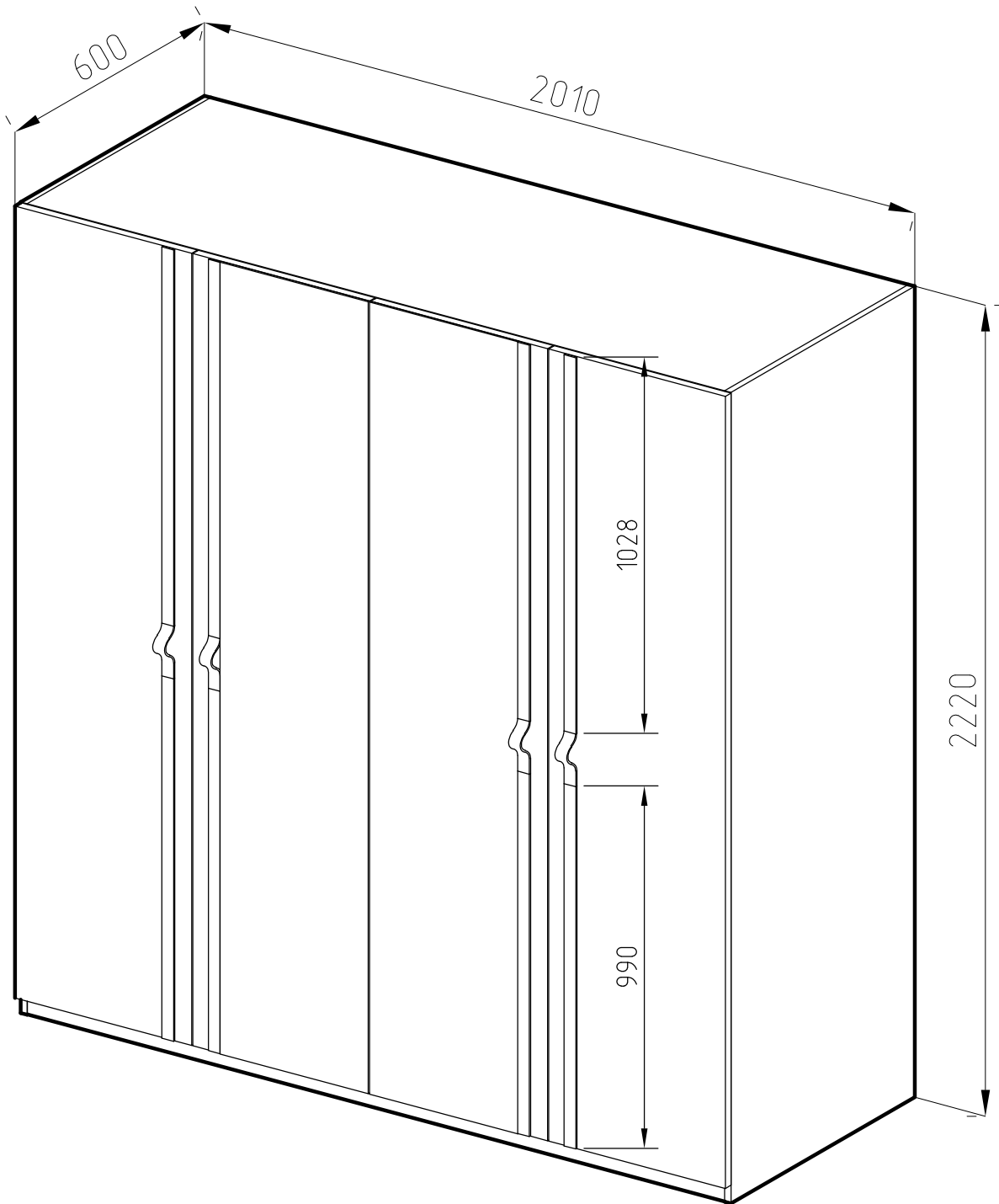

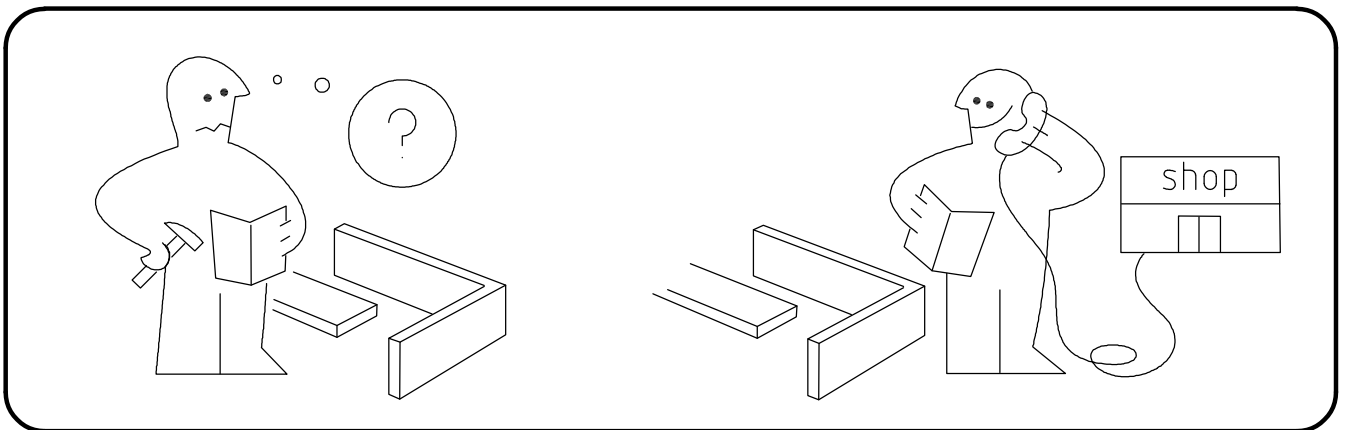

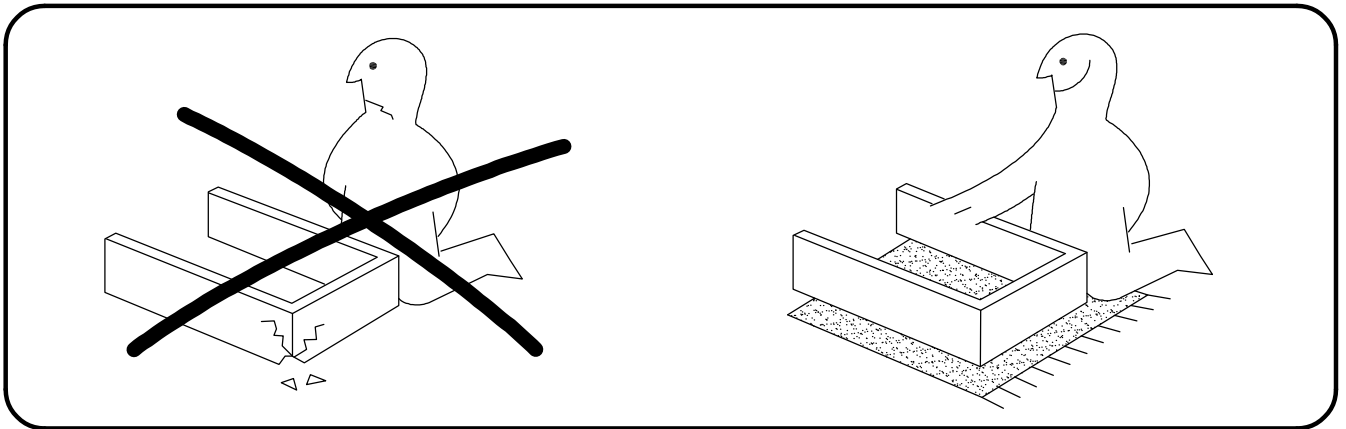

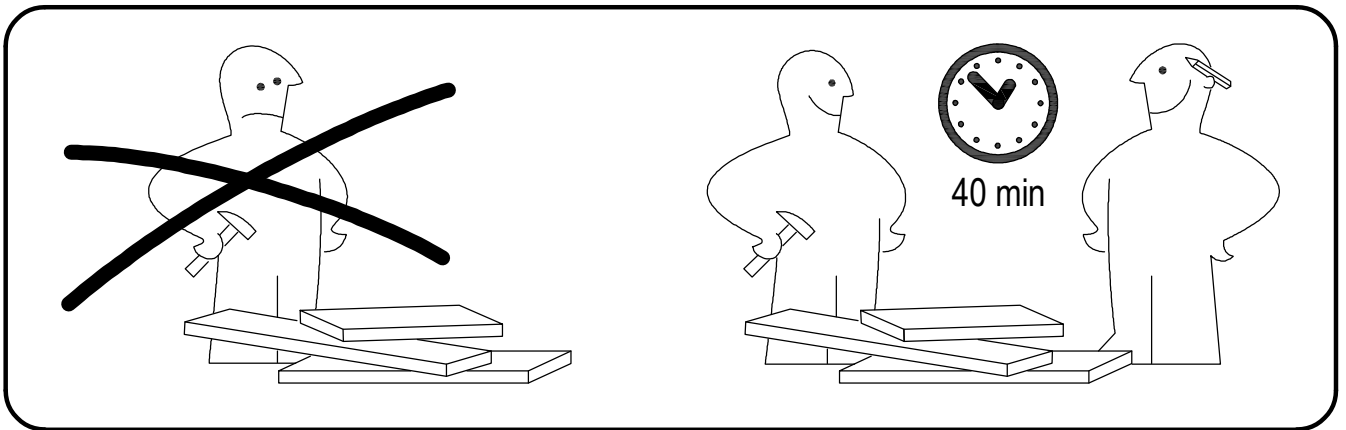

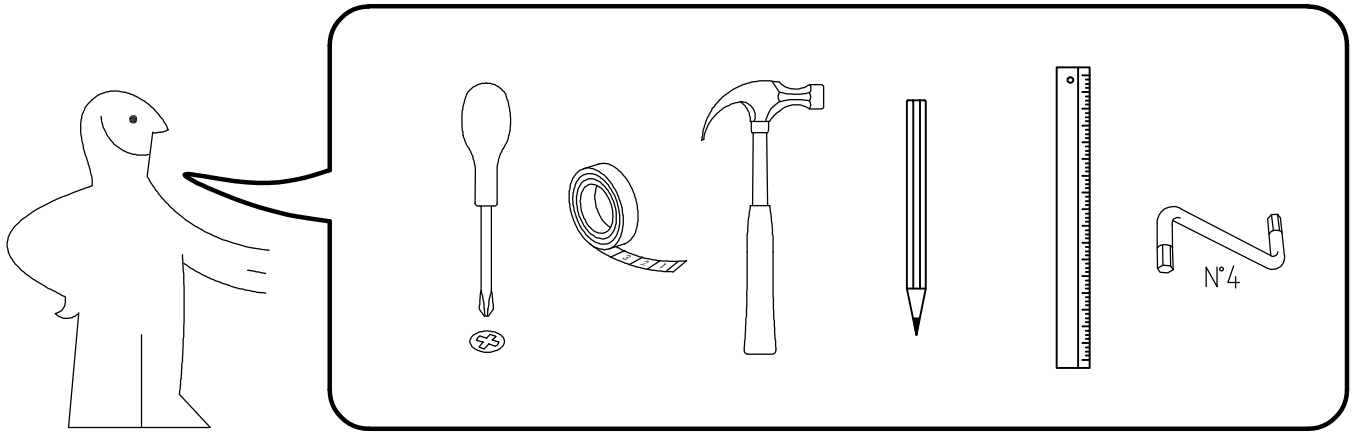

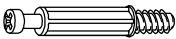

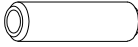

EXTAZA

WARDROBE 4D



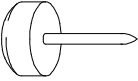
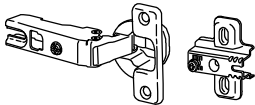
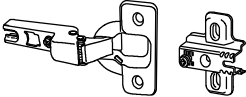
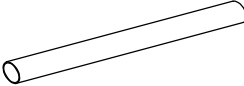

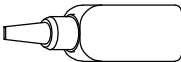
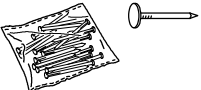
 A1 8*30mm x40	 C1 4*3mm x36	 D x36
 D1 16mm x36	 E9 4*16mm x52	 F3 6,3*13mm x20
 G1 M 4*8mm x20	 G6 M 4*25mm x8	 G15 x10
 H1 M 4 x8	 I28 x4	 J4 x16
 K1 x6	 L1 x10	 L2 x10
 P1 L-478 ϕ 25 L-975	 P3 R-11 M/25 x4	 P4 L-380 L-2000
 R1 x1	 R3 1.4*25mm 0.08kg	

N°	a*b	x	N°	a*b	x	N°	a*b	x
1L	2216x580	1	7	978x470	1	13R	2164x500	1
1R	2216x580	1	8	480x470	1	14L	2164x500	1
2	2130x580	1	9	978x470	1	14R	2164x500	1
3	1730x470	1	10	480x470	3	15	2162x504	2
4	1974x580	1	11	978x150	1	16	2162x496	2
5	1974x580	1	12	1974x50	2			
6	978x470	2	13L	2164x500	1			

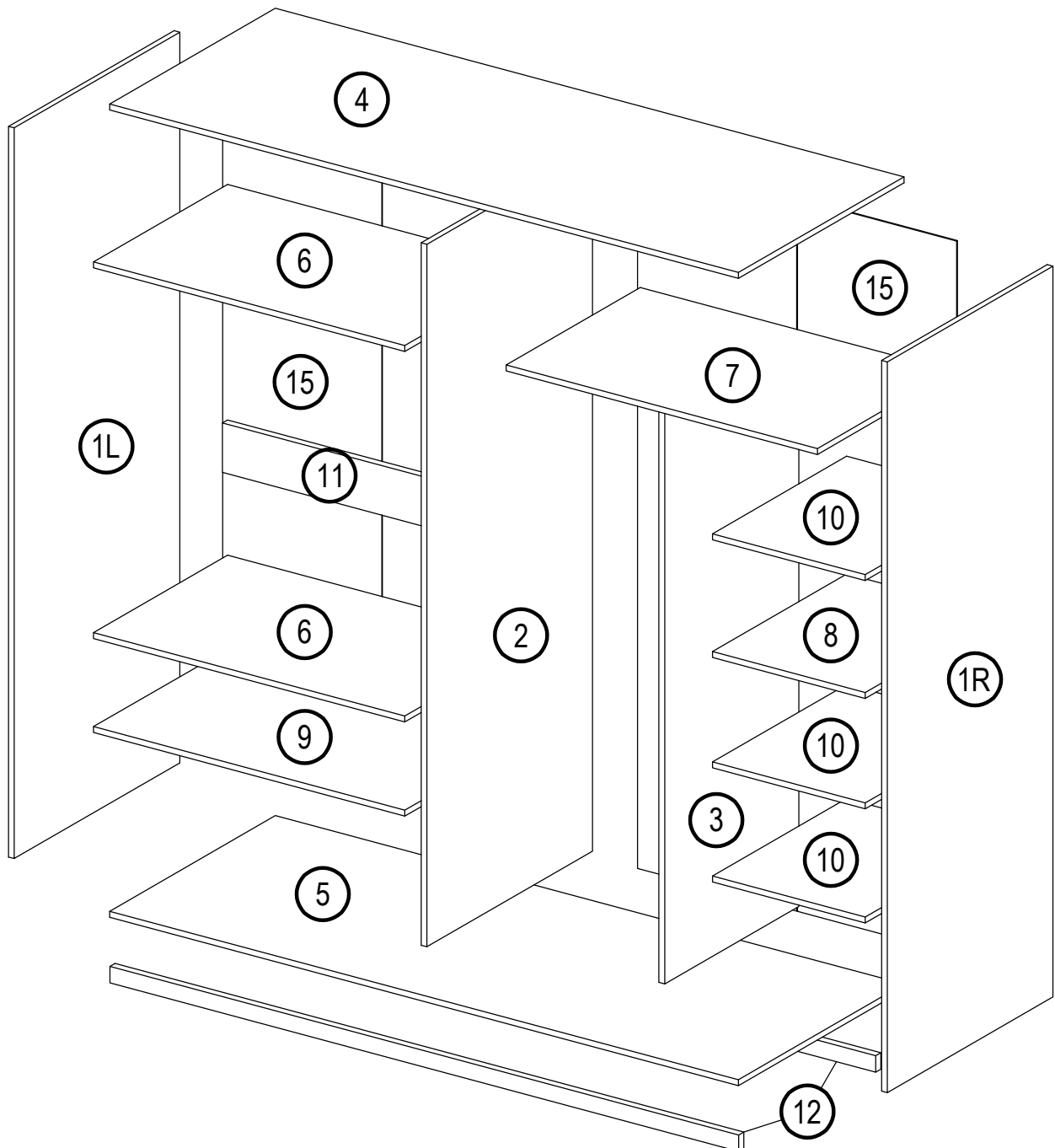

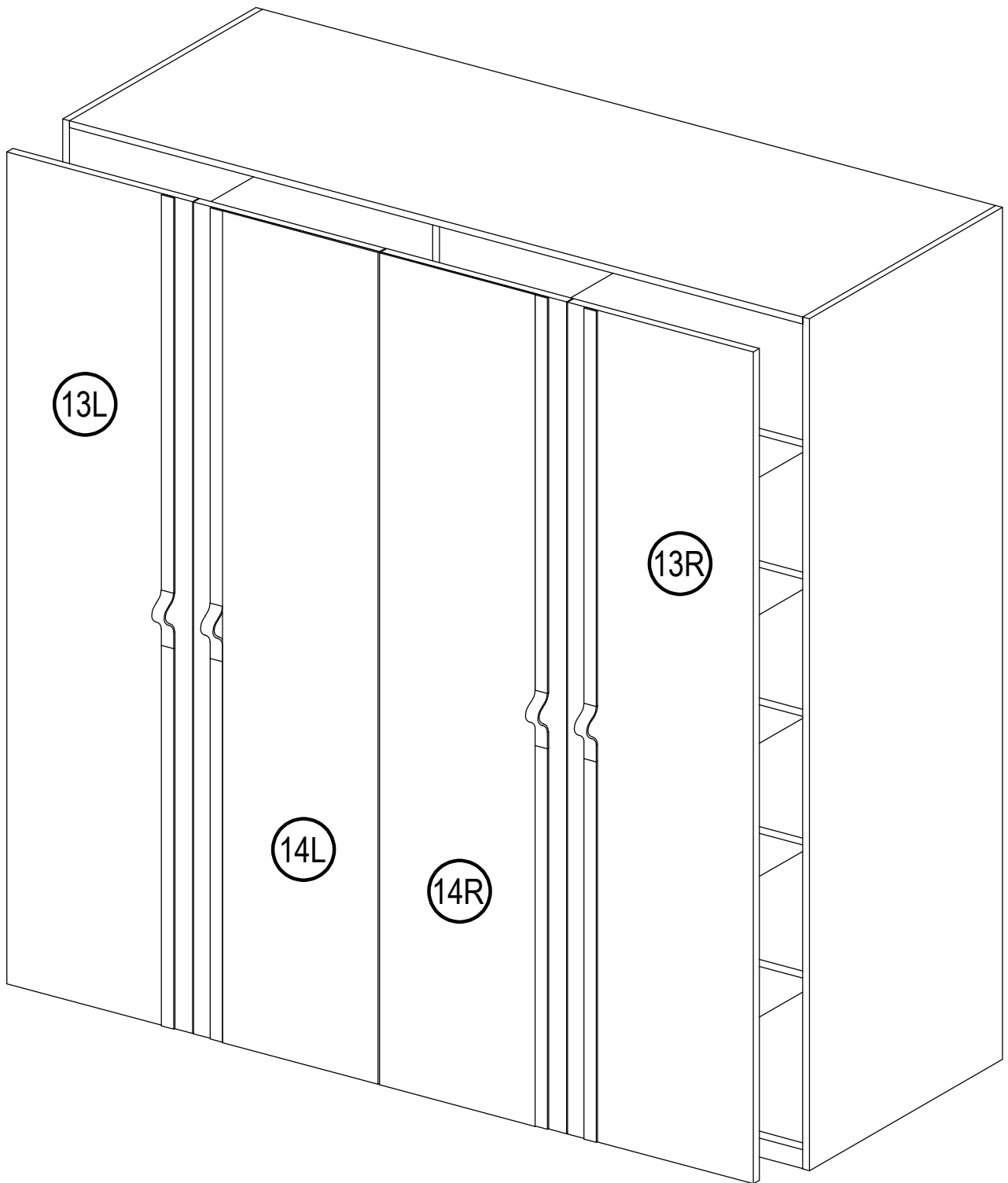

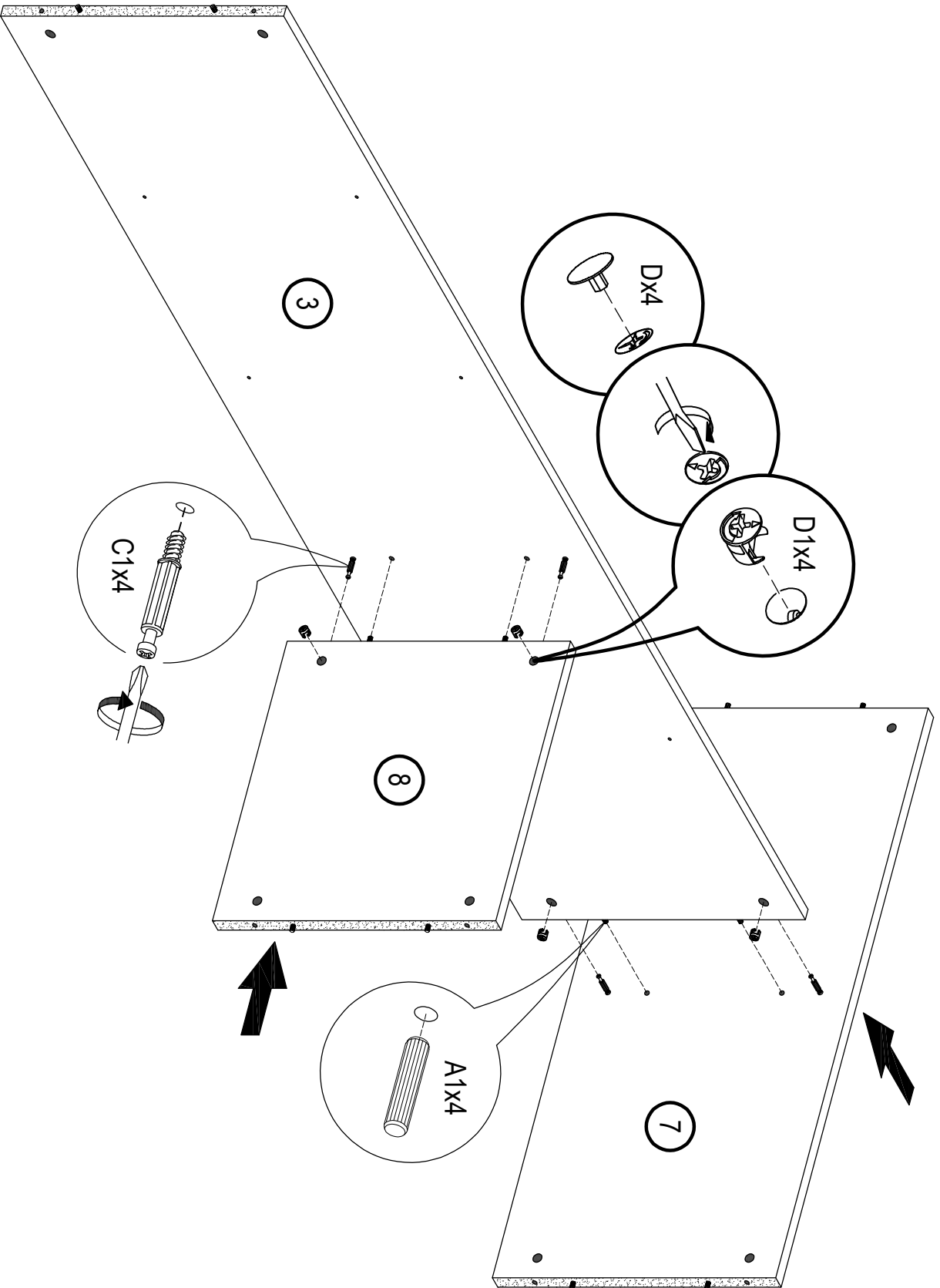

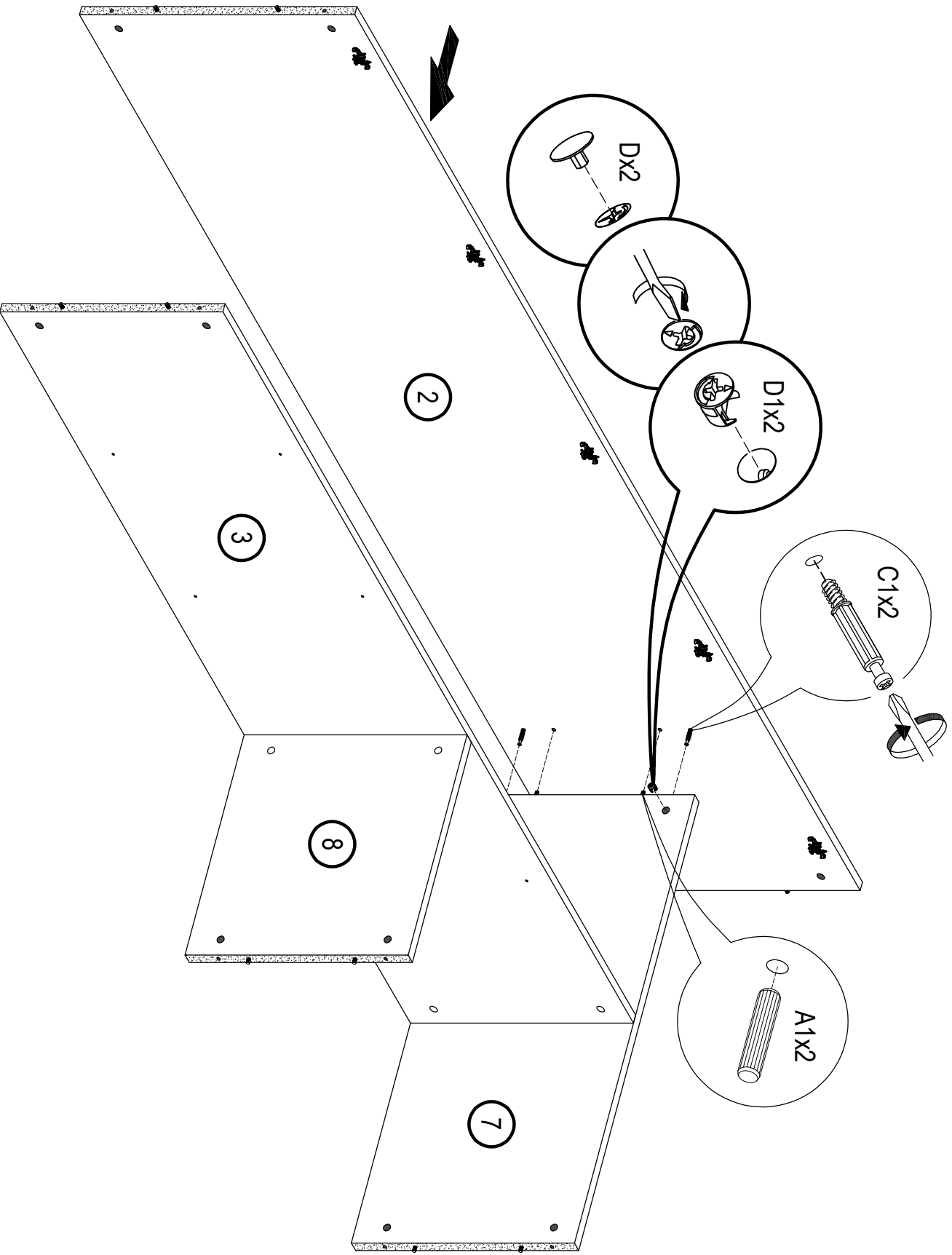

3

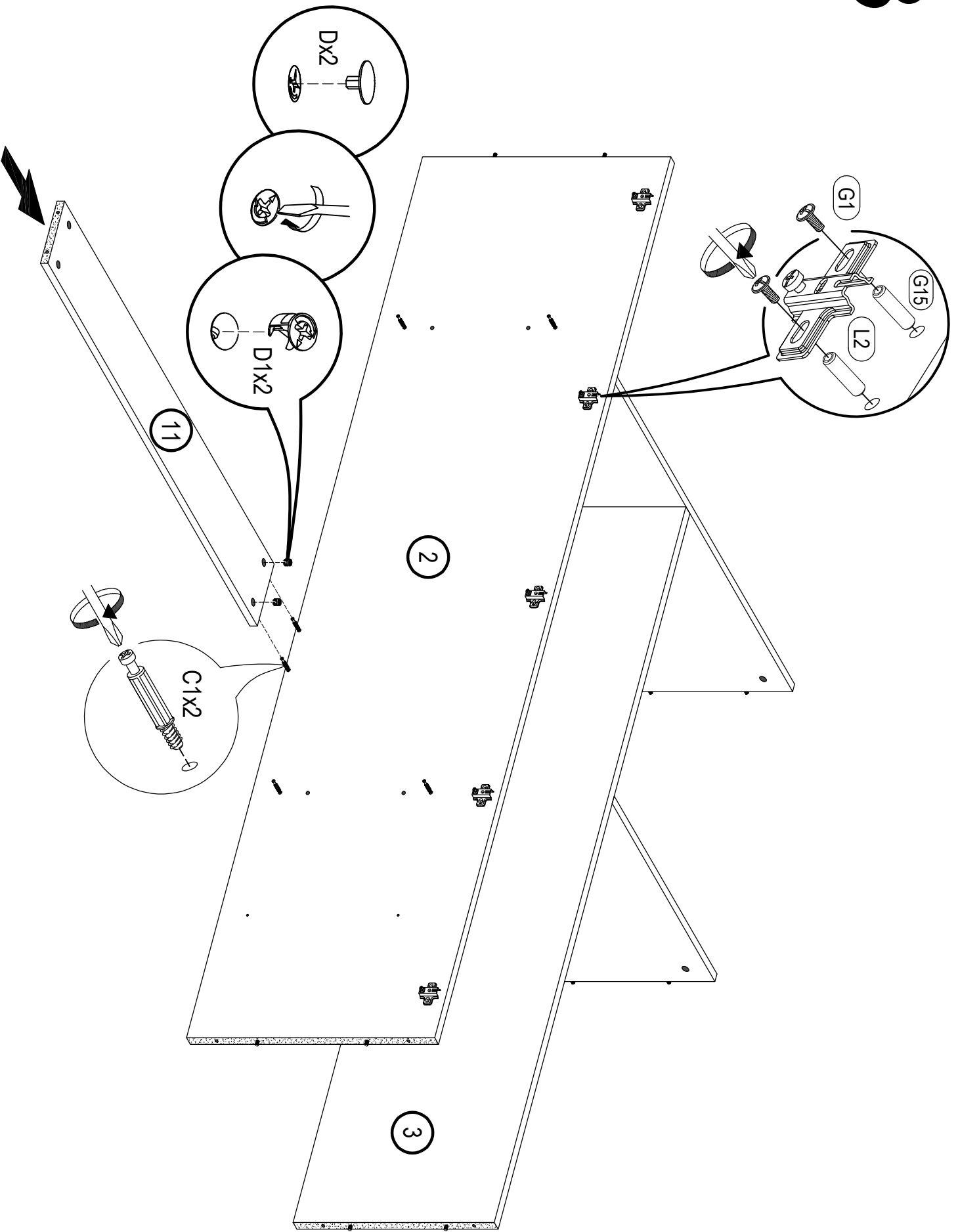

4

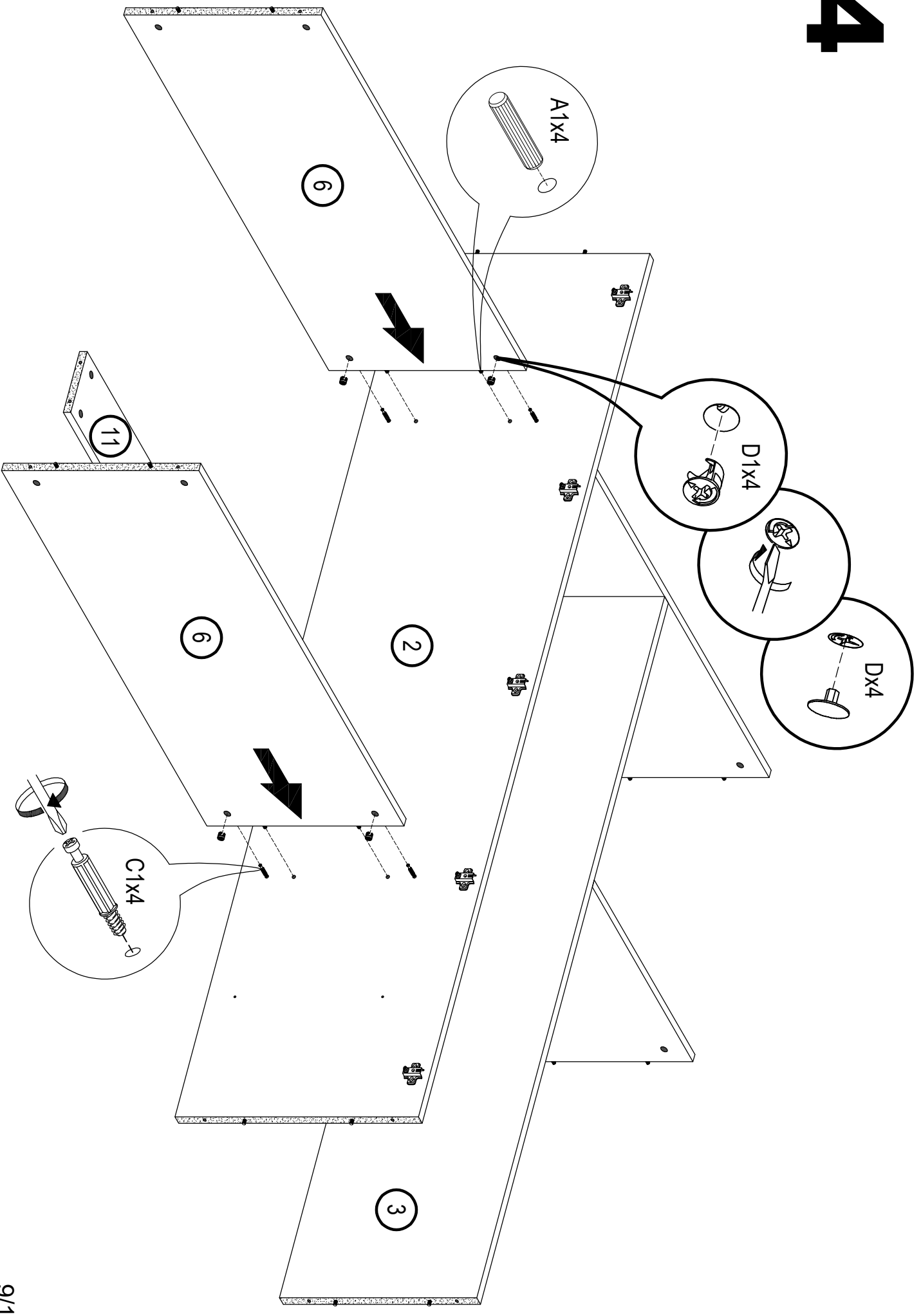

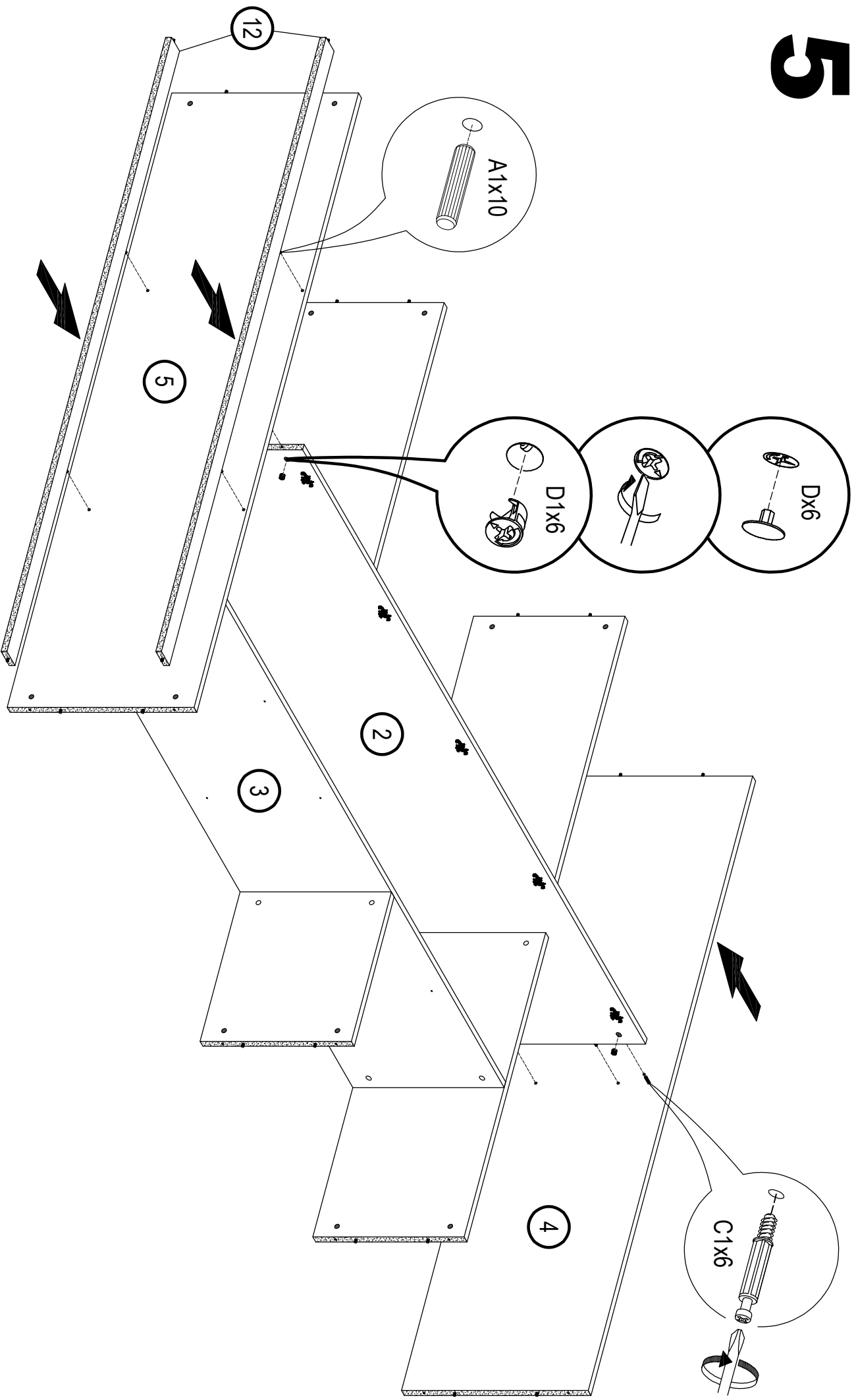

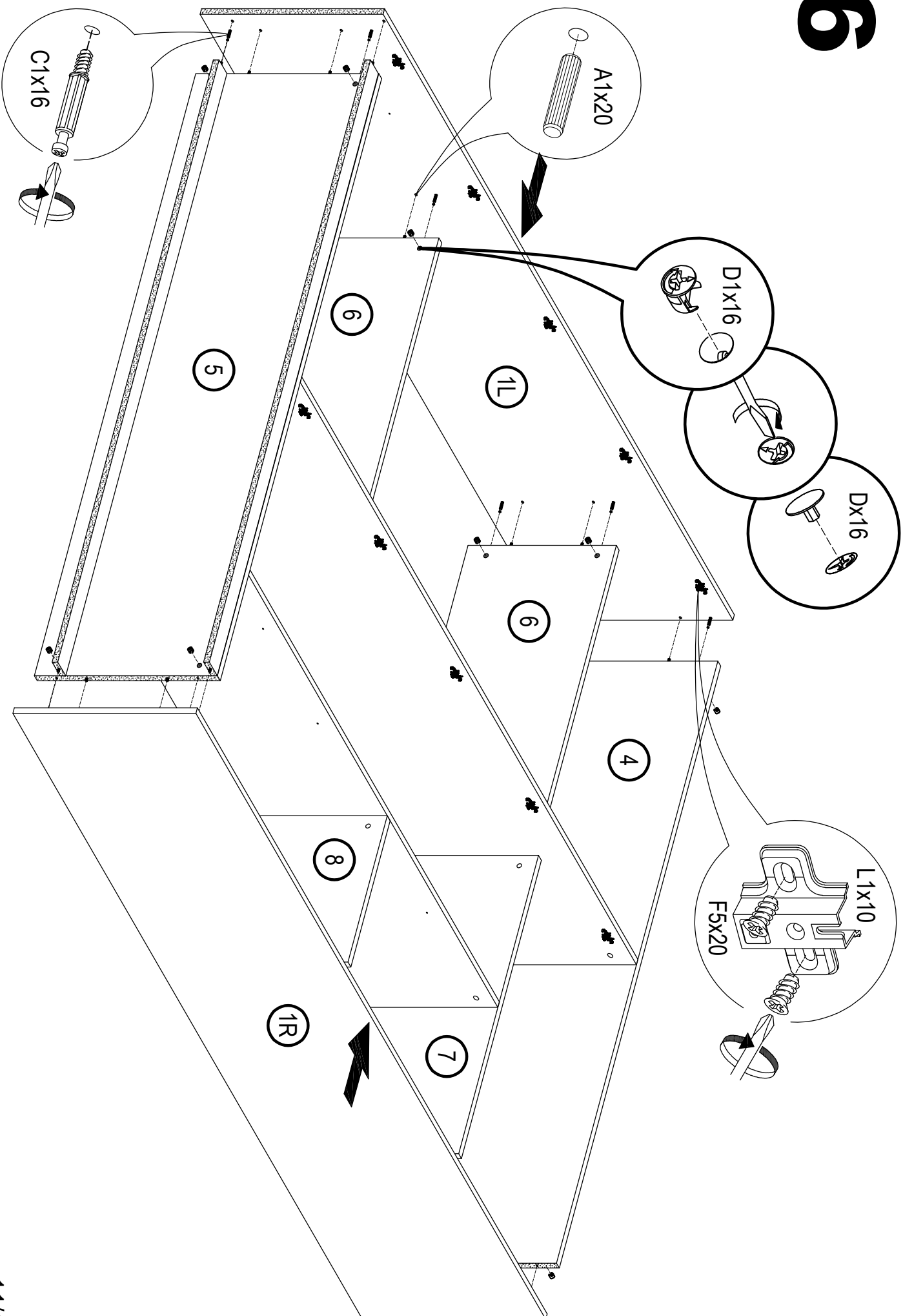

7

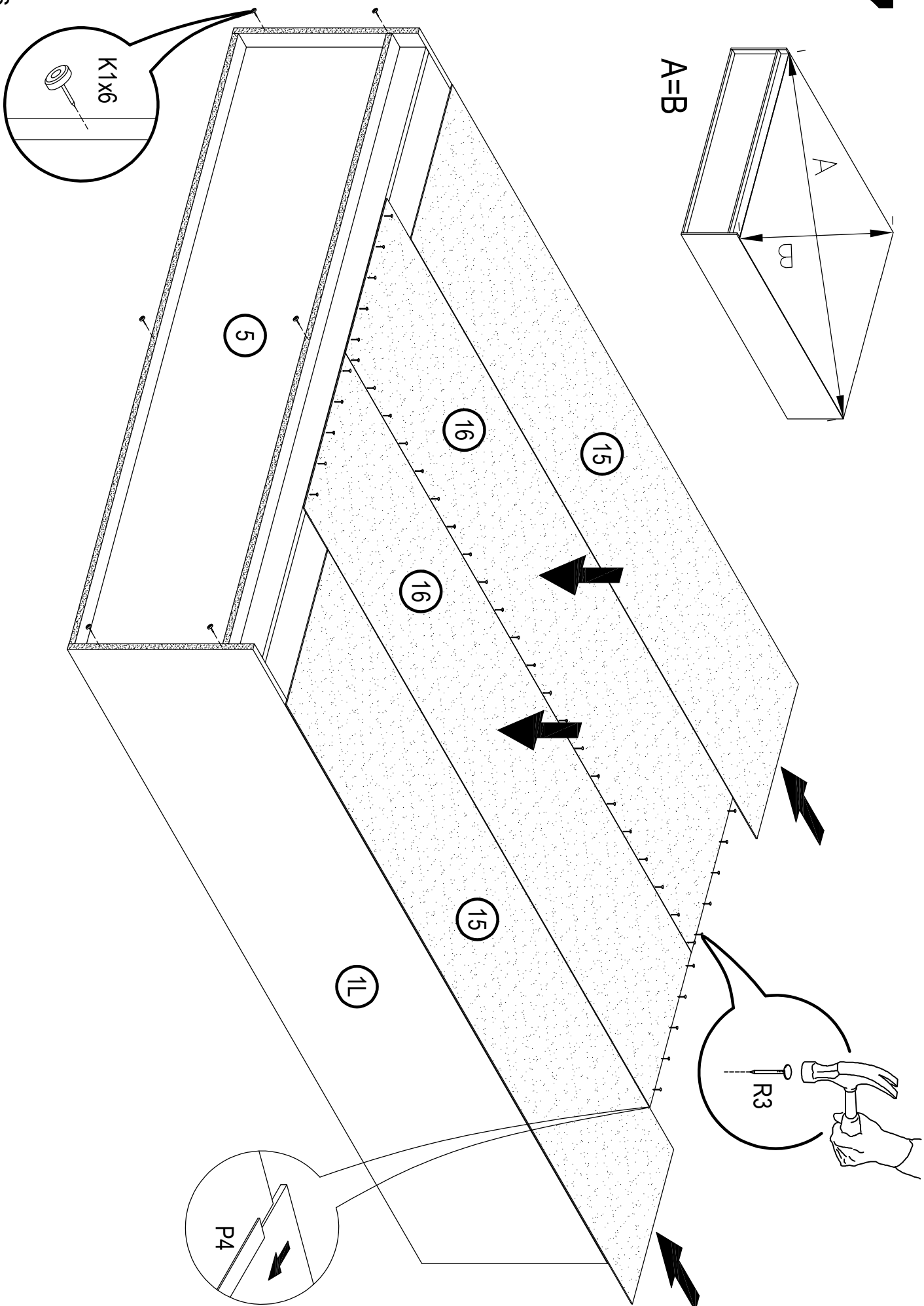
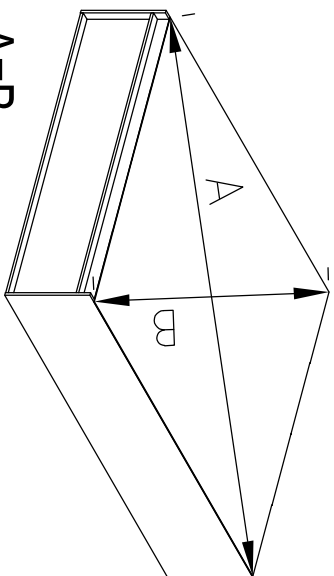

8

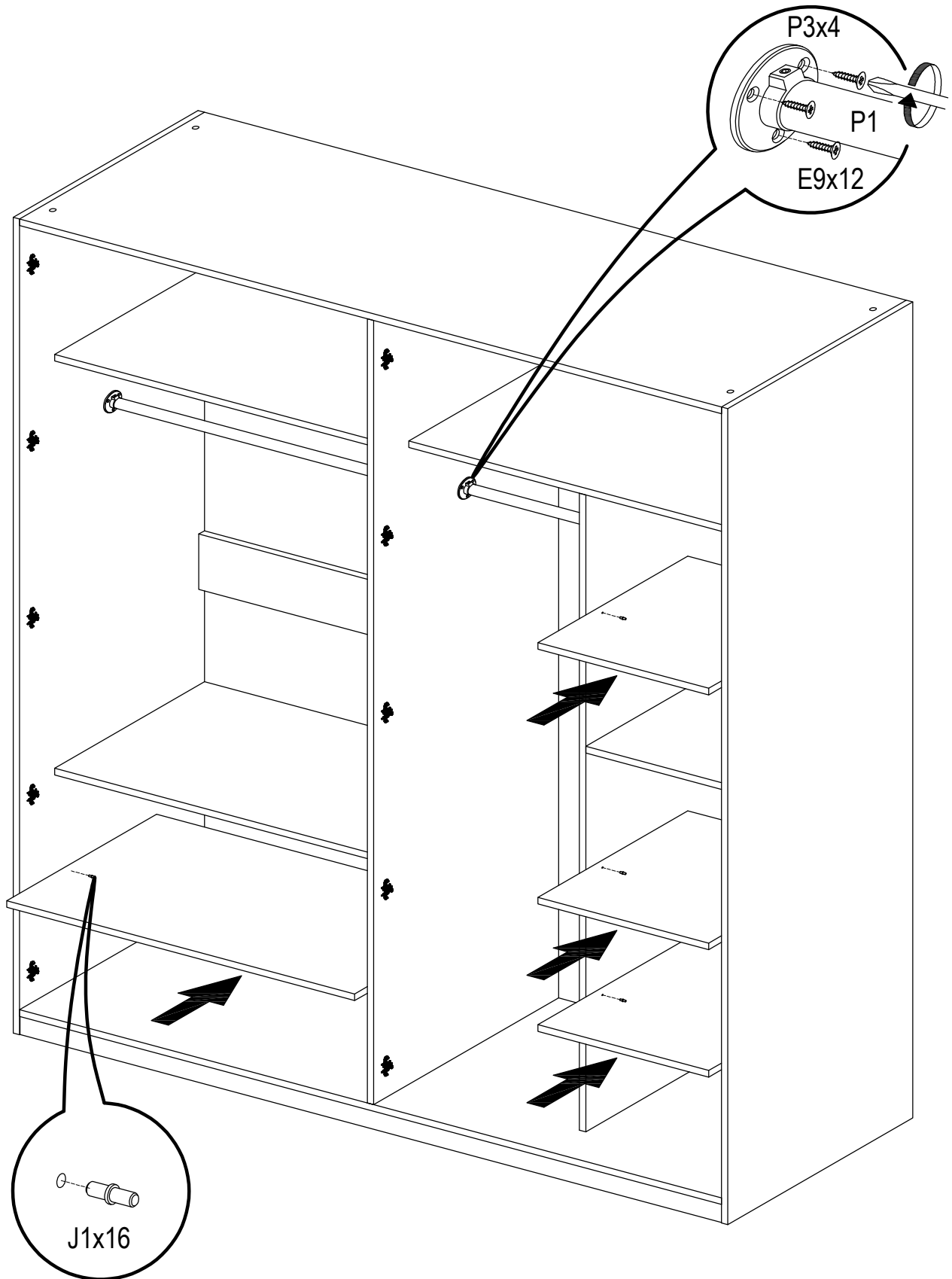

9

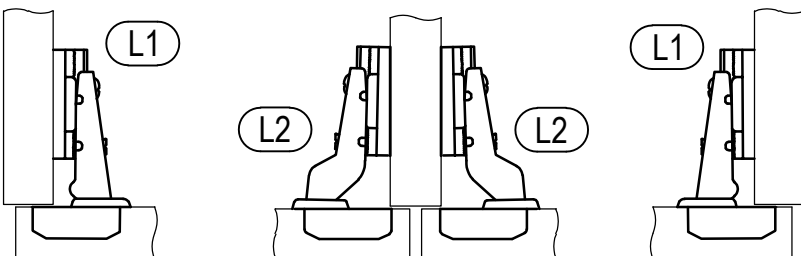
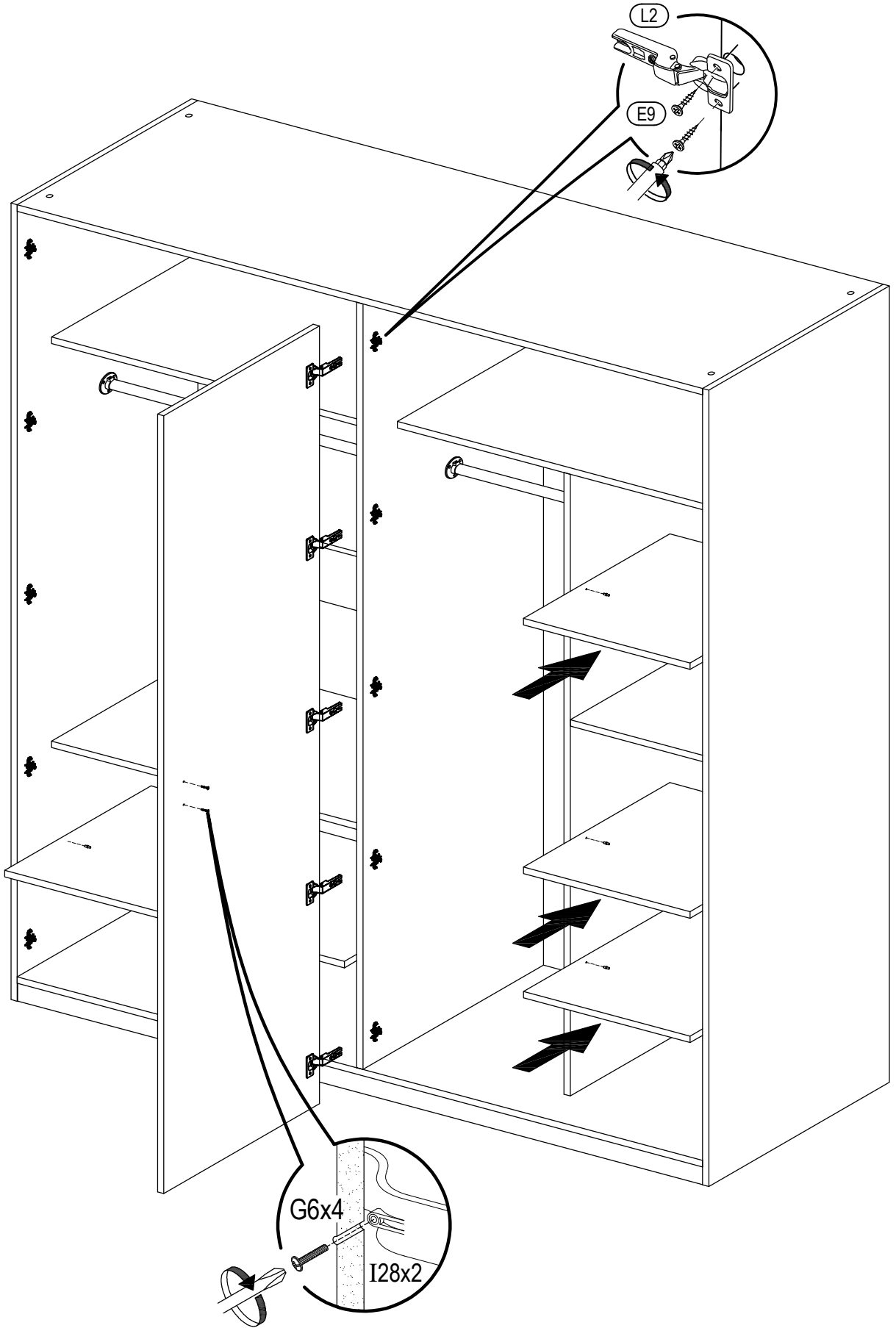

10

