

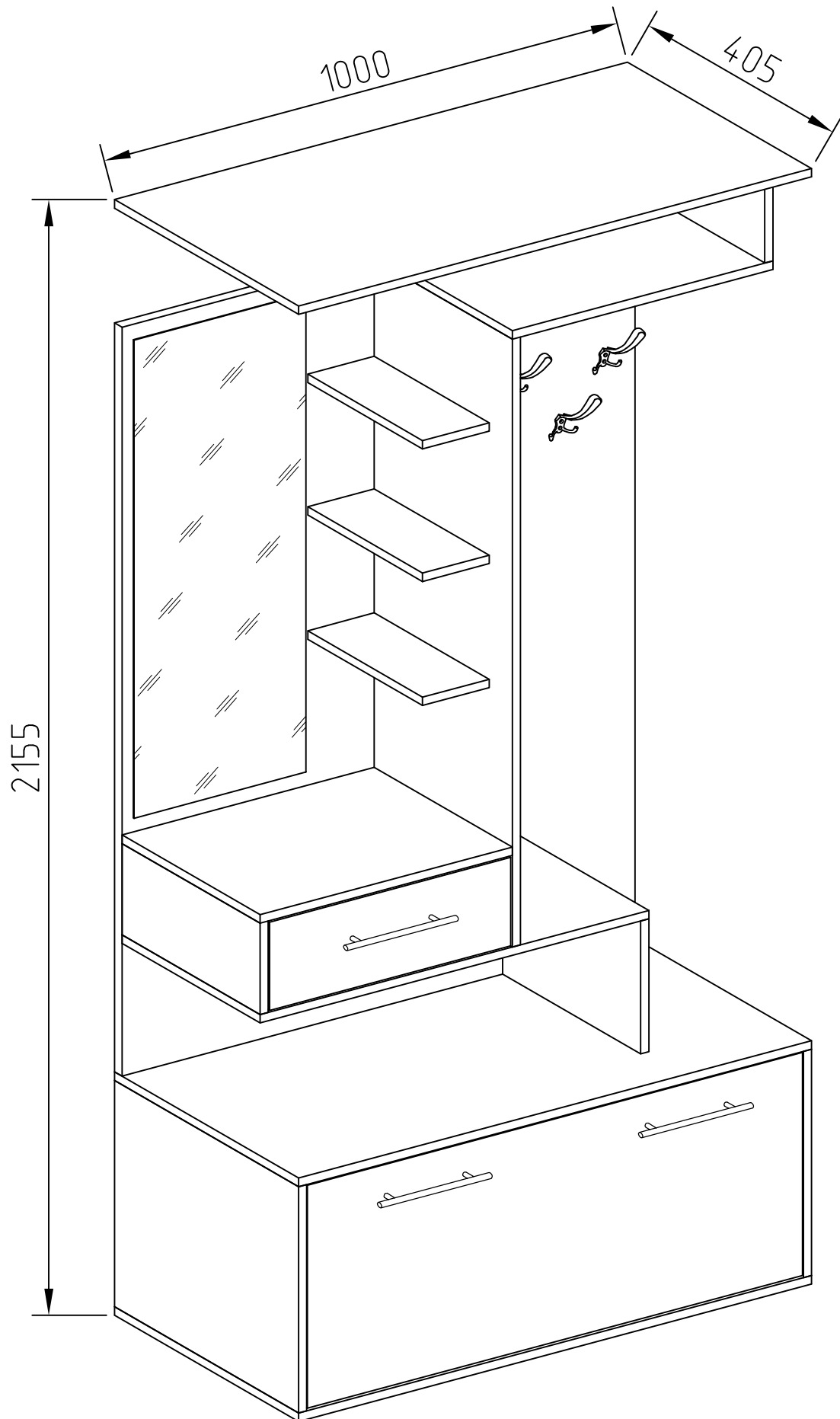

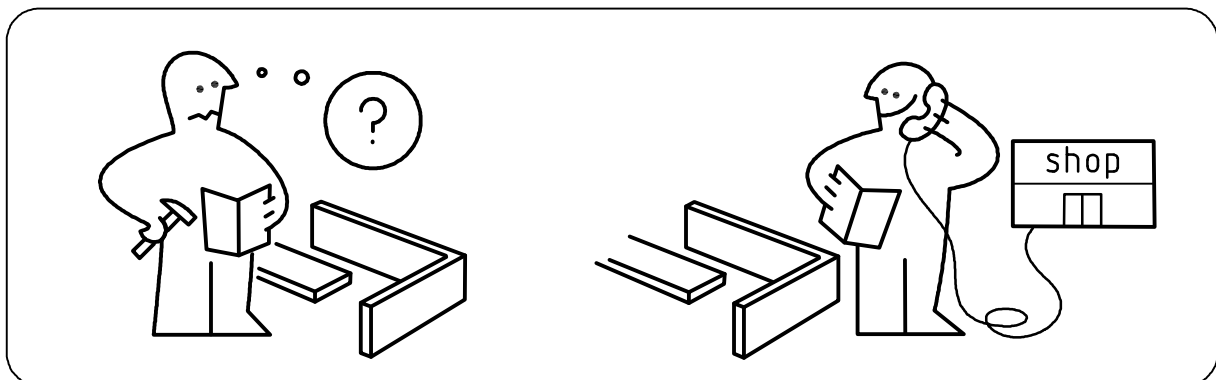

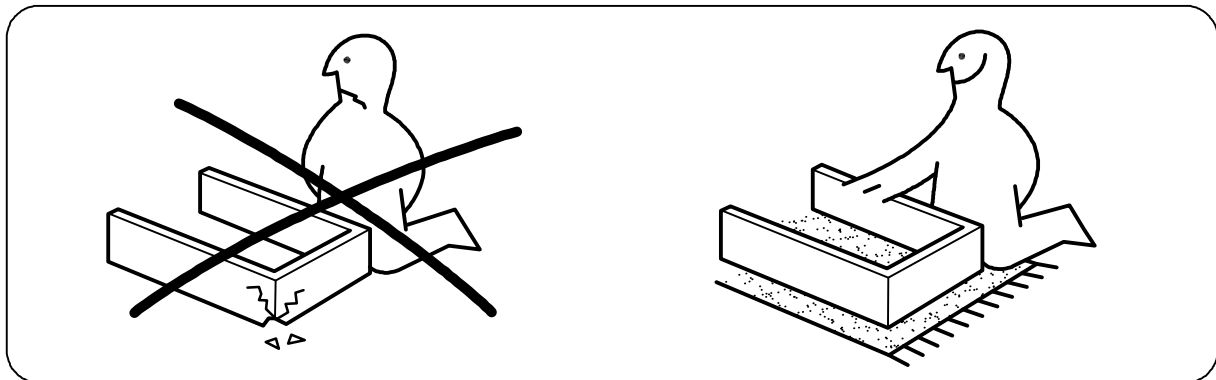

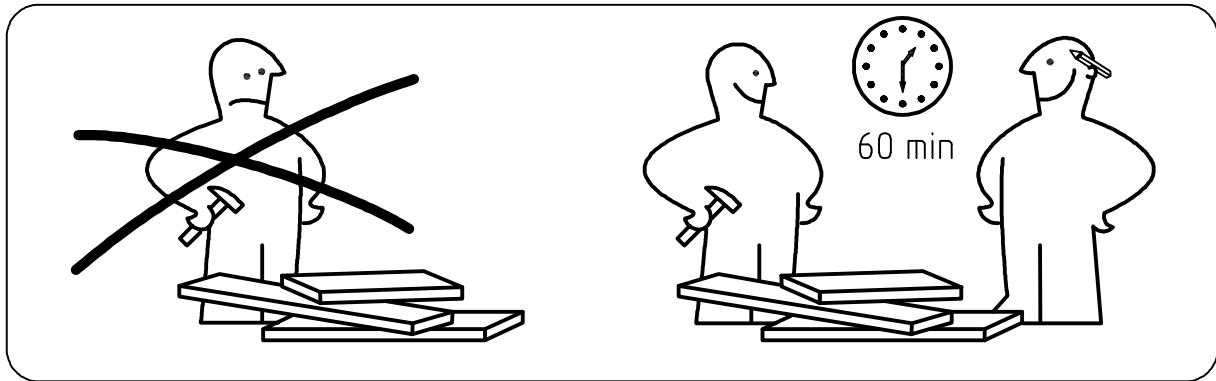

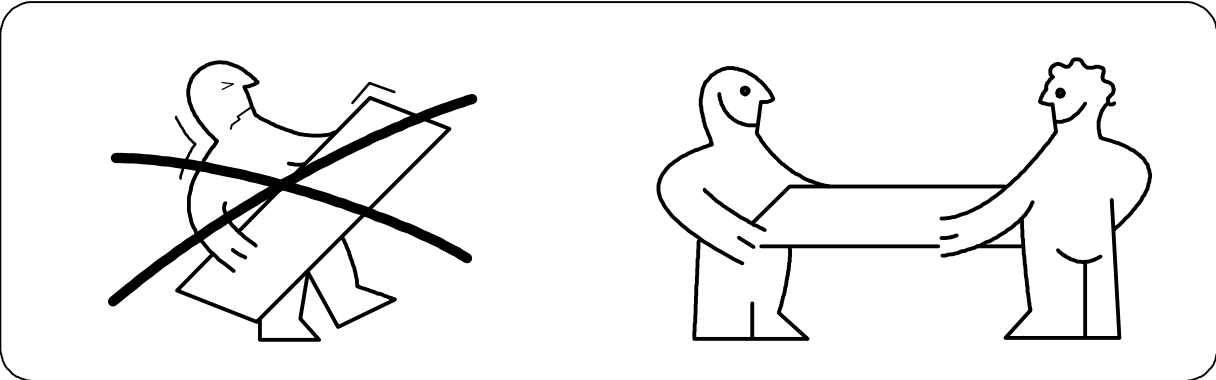
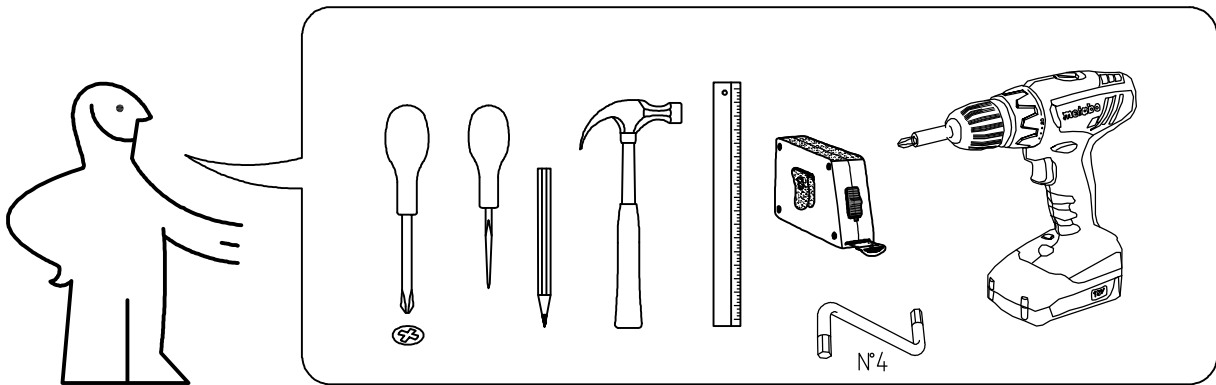





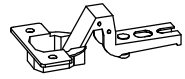



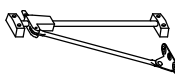

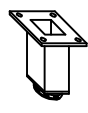
AMINA



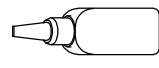
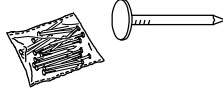
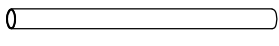
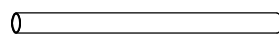
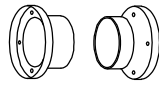

 (B1) 6,3*50mm x49	 (B) x20	 (H1) M 4 x6
 (C1) 5*30mm x2	 (D1) 16mm x2	 (D) x2
 (L3) x2	 (F1) 6,3*13mm x4	 (E8) 4*16mm x4
 (J1) x4	 (N4) L+R x2	 (E4) 3*20mm x8
 (E3) 3*15mm x38	 (K9) L-60 MM x5	 (M1) L-250mm x1
 (A1) 8*30mm x16	 (A2) 8*50mm x3	 (E2) 3*13mm x8
 (R1) x1	 (R3) 1.4*25mm 0.05kg	 L-198 MM x1
 L-248 MM x1	 (P3) R-11M/25 x4	 (X2) x3
 (I11) x3		 (G10) M 4*45mm x6

No	a*b	x	No	a*b	x
1	426x400	2	14	130x250	3
2	426x382	1	15	1410x1000	1
3	1144x300	1	16	216x700	1
4	250x300	1	17	960x418	1
5	172x300	1	18	468x164	1
6	200x300	1	19	250x120	2
7	1000x400	1	20	420x120	1
8	492x300	1	21	253x448	1
9	1000x400	1	22	996x455	1
10	1000x400	1	23	850x345	1
11	758x300	1		L=198	1
12	508x300	1		L=248	1
13	476x382	2			

