

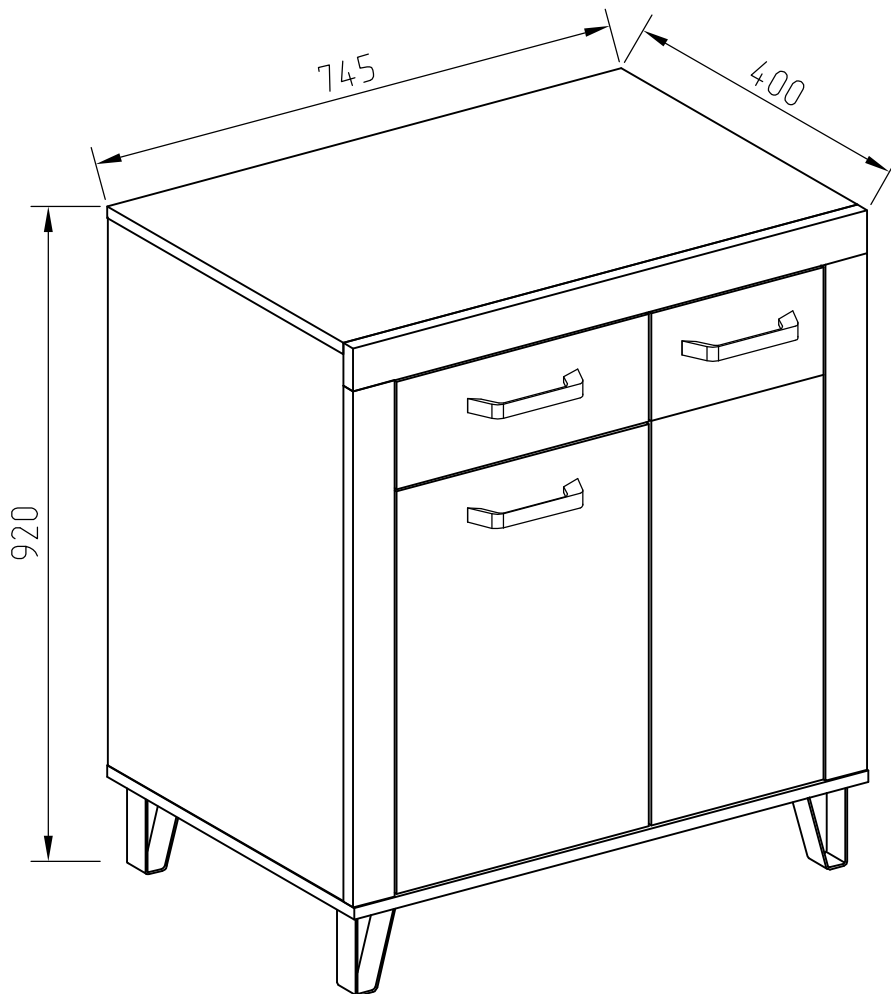

RIO









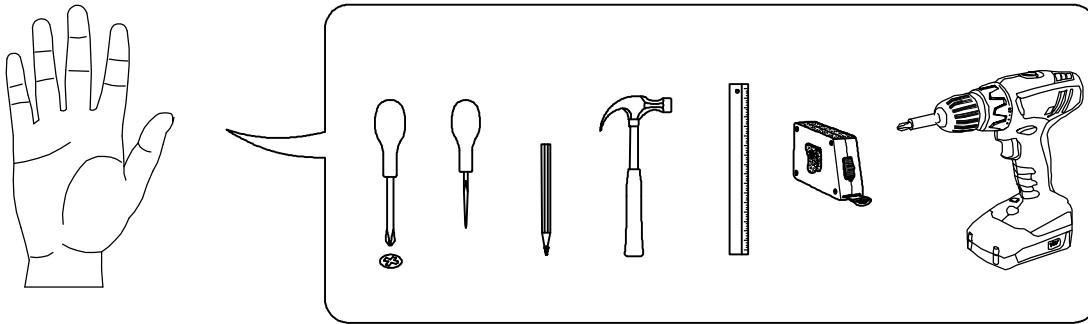



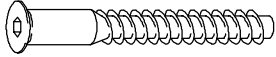

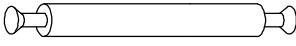
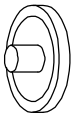

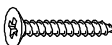
CABINET 2D1Dr

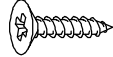

RIO

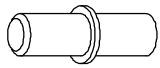
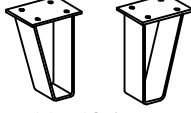
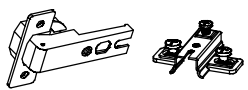
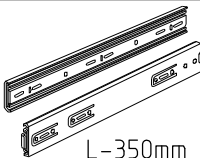
CABINET 2D1Dr

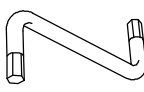

 A1 8*30mm x25	 A1 8*50mm x4	 B x13
 B1 6,3*50mm x13	 C1 5*30mm x19	 C2 8*56mm x4
 D x27	 D1 16mm x27	 E4 3*20mm x4
 E5 3,5*16 x8	 E11 4*16mm x24	 E13 4*35mm x6
 F2 6,3*13mm x8	 H2 x14	 I23 x3
 J1 5*16mm x8	 K18 H-120mm x4	 L4 180° x4
 M2 L-350mm x1	 O1 x4	 R4 N°4 x1
 U3 x6		

RIO
CABINET 2D1Dr

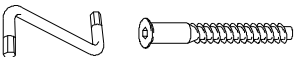
No	a*b	x	N°→...
1L	768x382	x1	1/2
1R	768x382	x1	1/2
2	768x368	x1	1/2
3	194x368	x1	2/2
4	746x382	x1	2/2
5	746x400	x1	2/2
6	405x366	x1	2/2
7	289x366	x1	2/2
8	406x94	x1	2/2
9	406x80	x1	2/2
10	746x60	x1	2/2
11L	60x723	x1	2/2
11R	60x723	x1	2/2
12a R	250x151	x1	2/2
12b R	250x567	x1	2/2
13	366x564	x1	1/2
14	366x151	x1	1/2
15L	350x90	x1	2/2
15R	350x90	x1	2/2
16	306x90	x1	2/2
17	343x315	x1	1/2
18	302x777	x1	2/2
19	418x777	x1	2/2
		x1	2/2

RIO

CABINET 2D1Dr

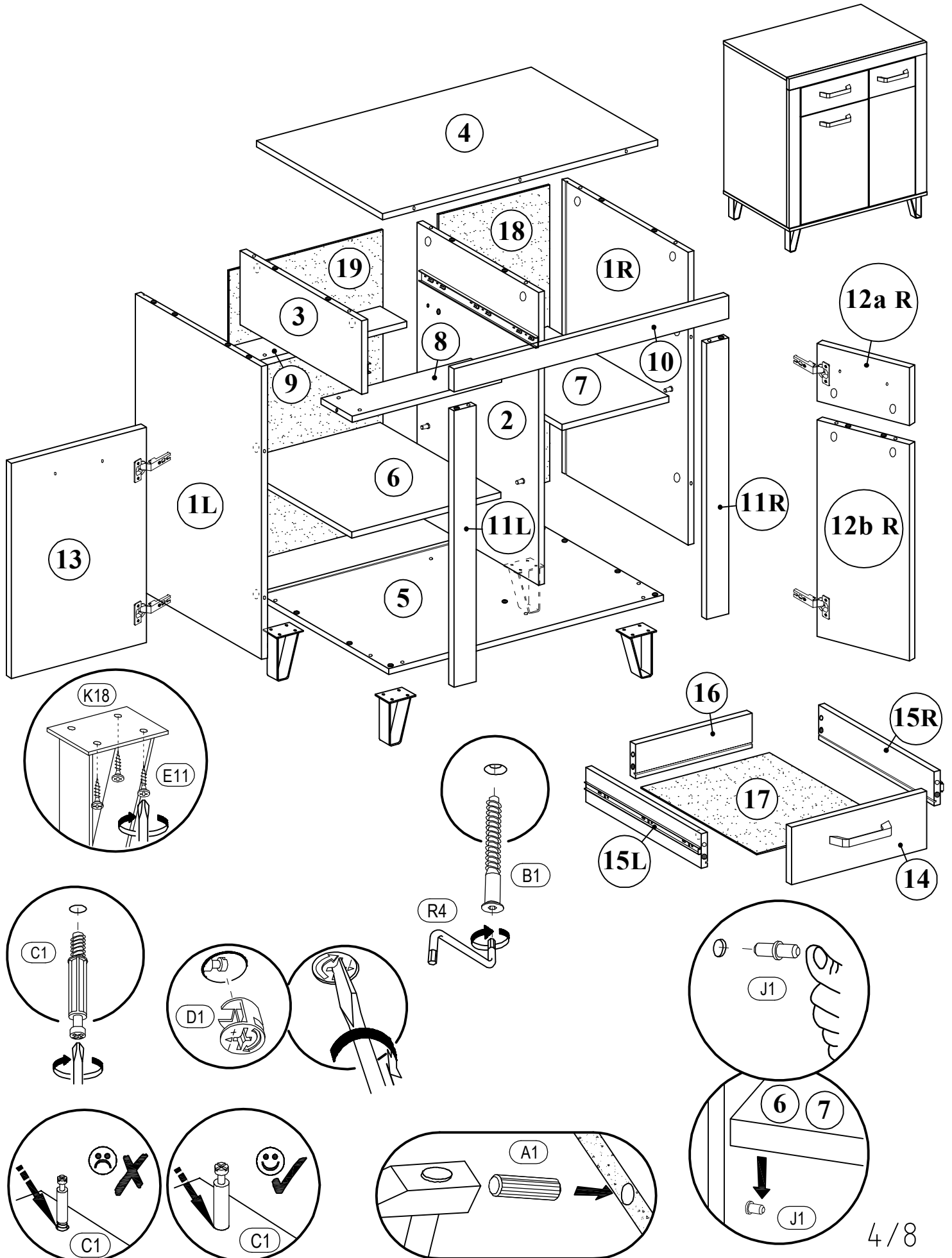

RIO

CABINET 2D1Dr

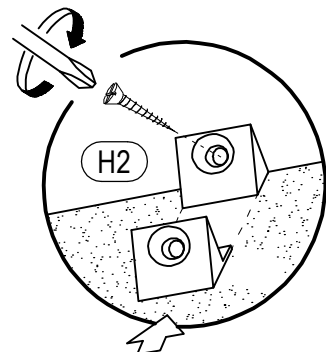
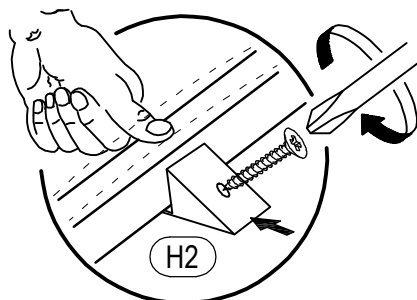
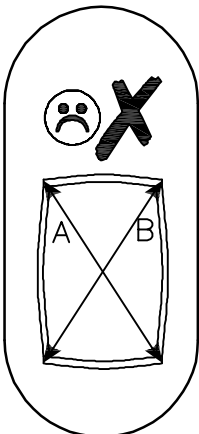
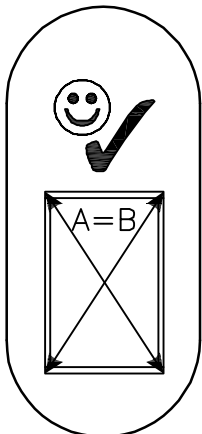
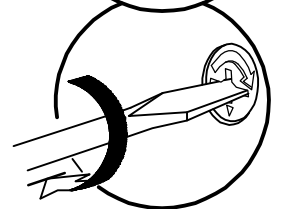
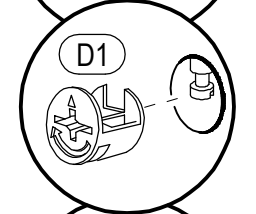
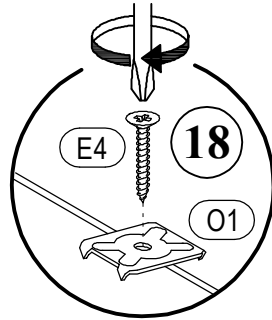
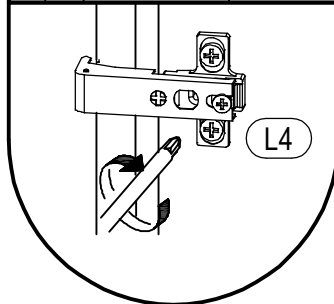
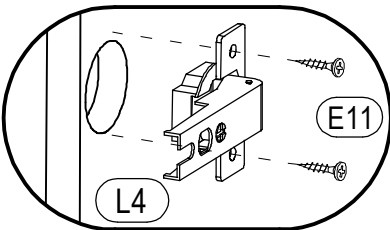
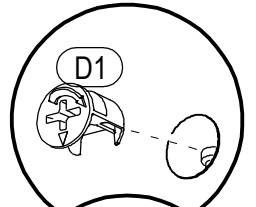
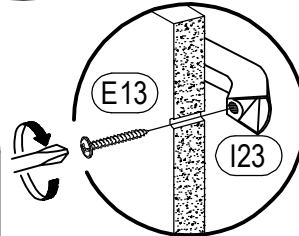
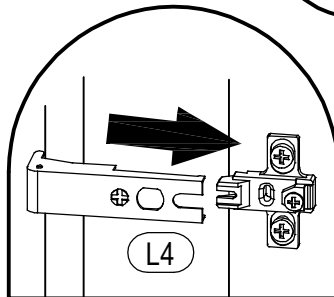
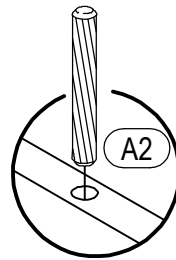
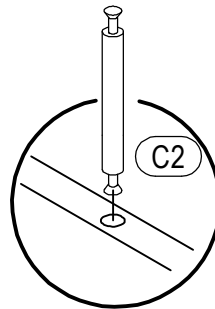
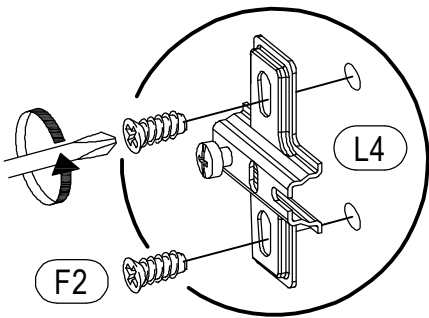
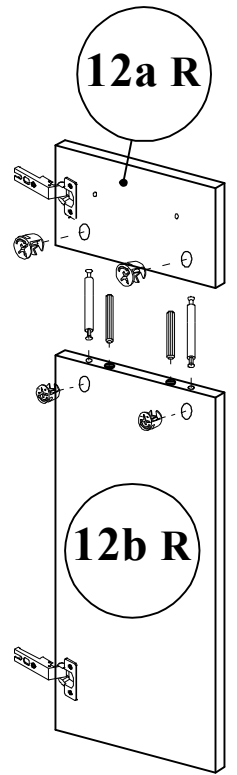
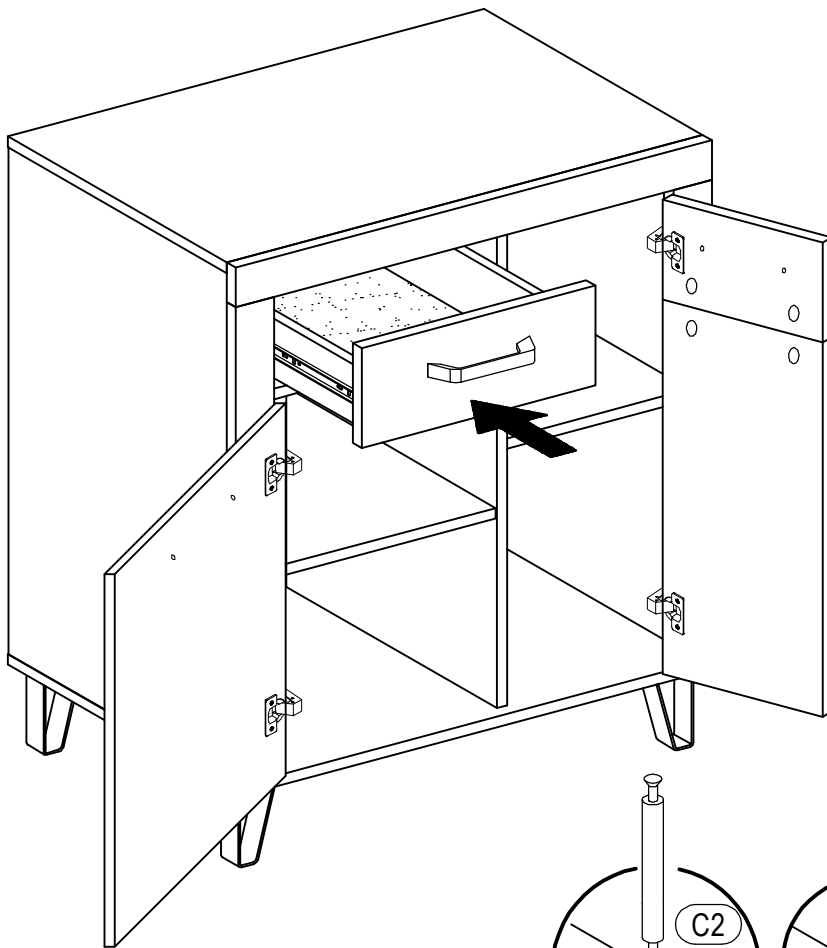

RIO

CABINET 2D1Dr

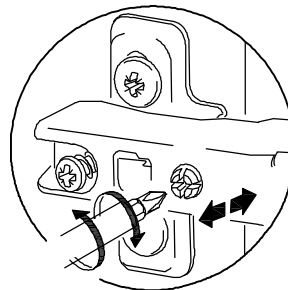
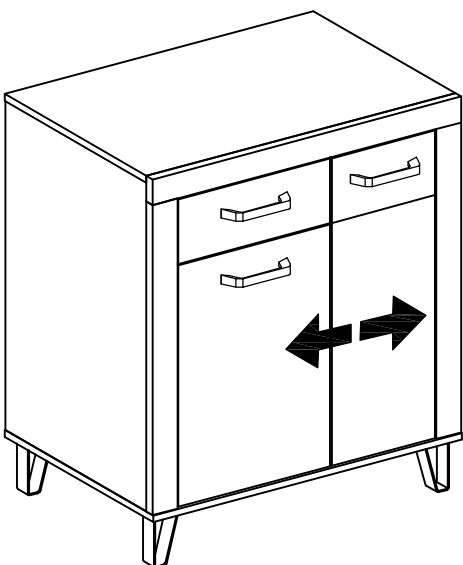
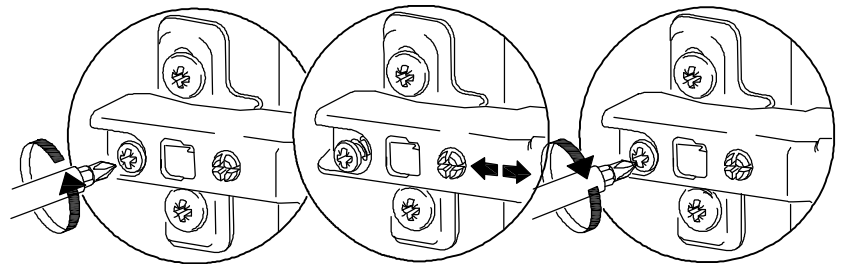
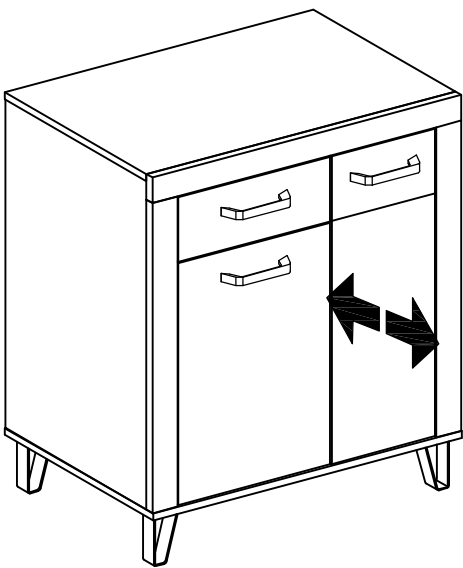
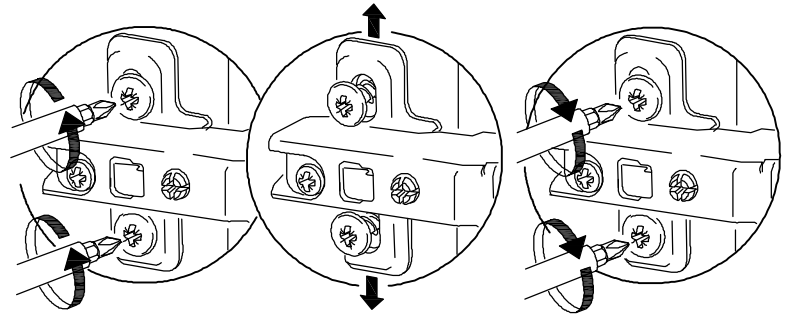
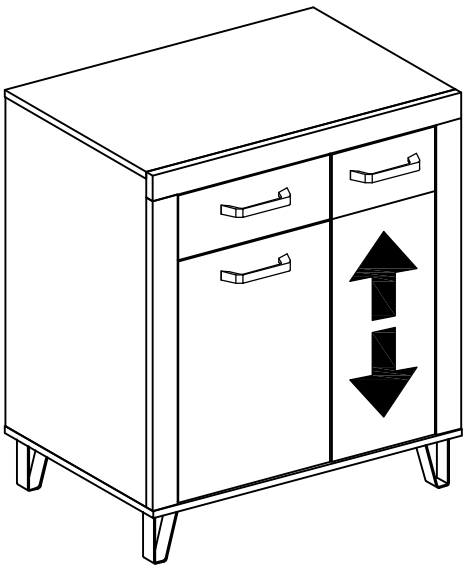

RIO

CABINET 2D1Dr

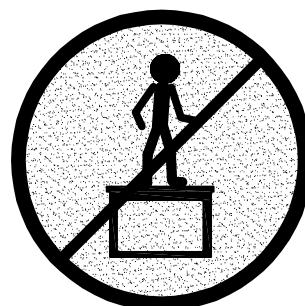
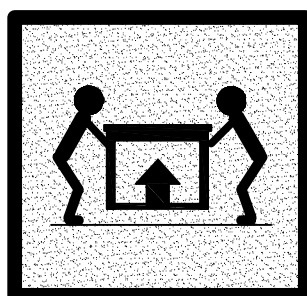
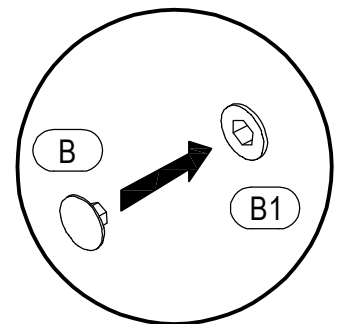
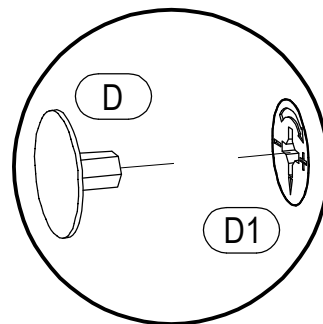
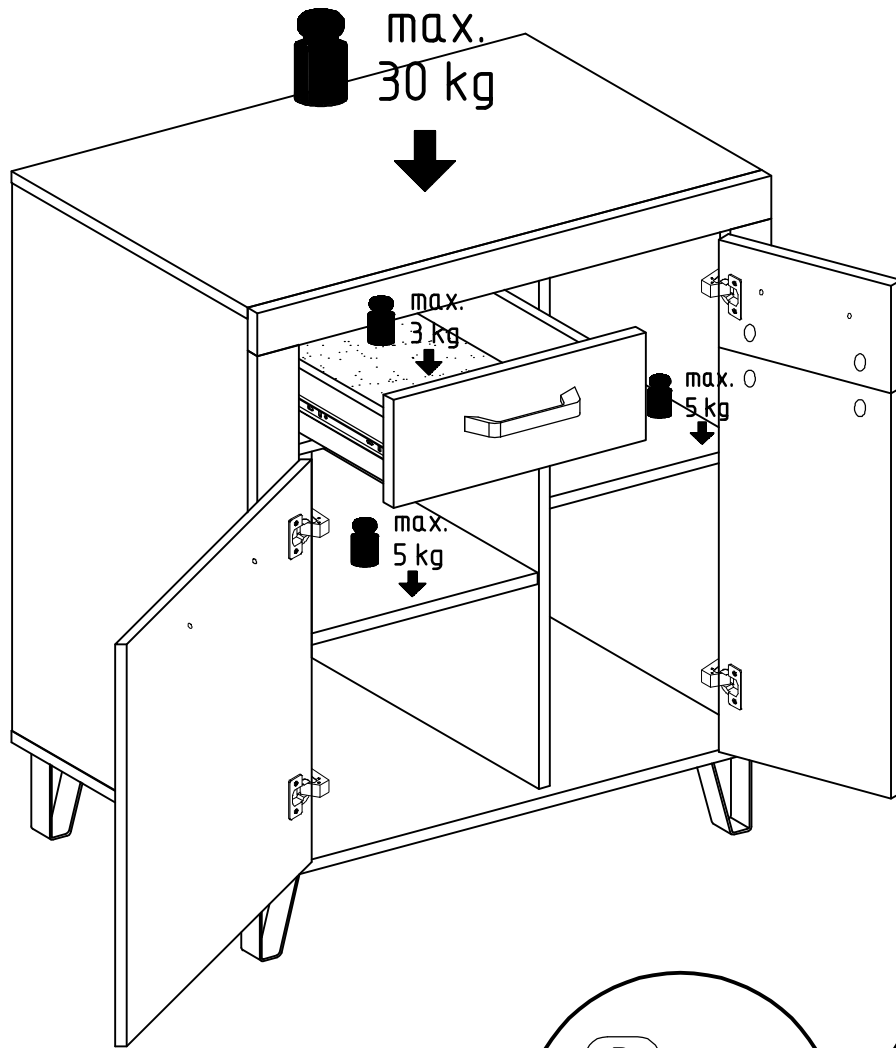

RIO
CABINET 2D1Dr

