

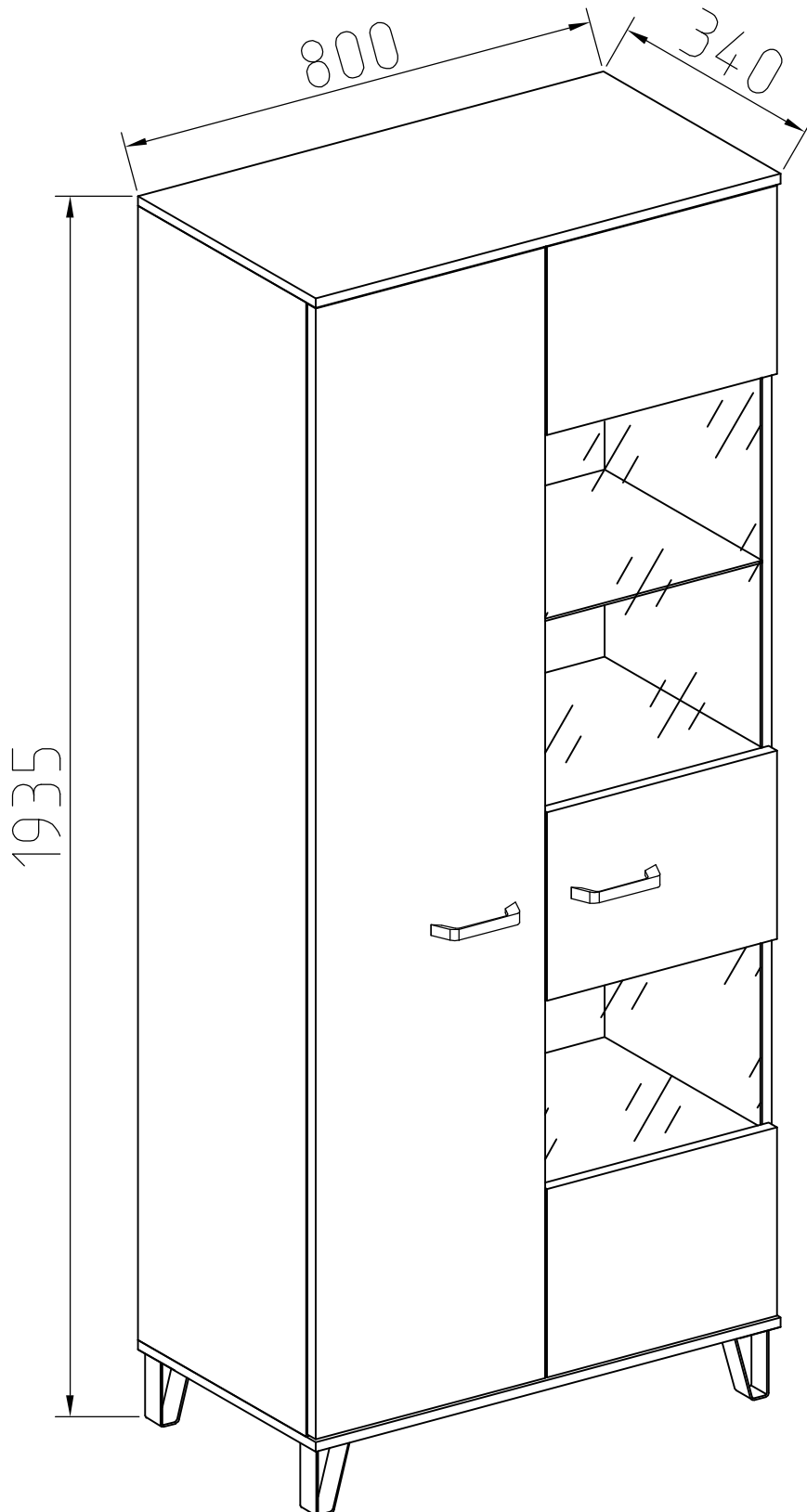

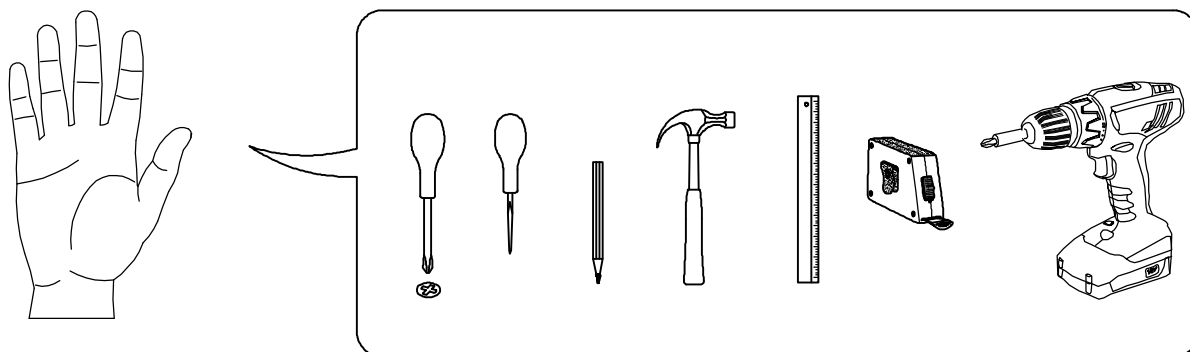







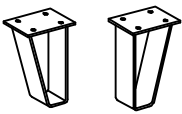
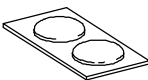
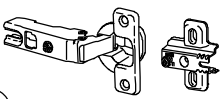

СВІТ МЕБЛІВ

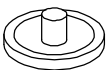
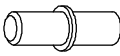
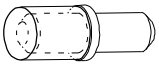
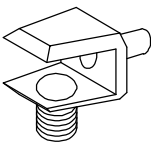
# RIO

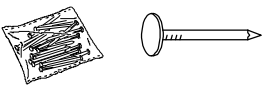
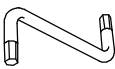
## WARDROBE 2D

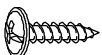
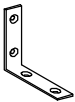
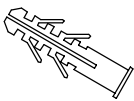

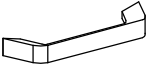





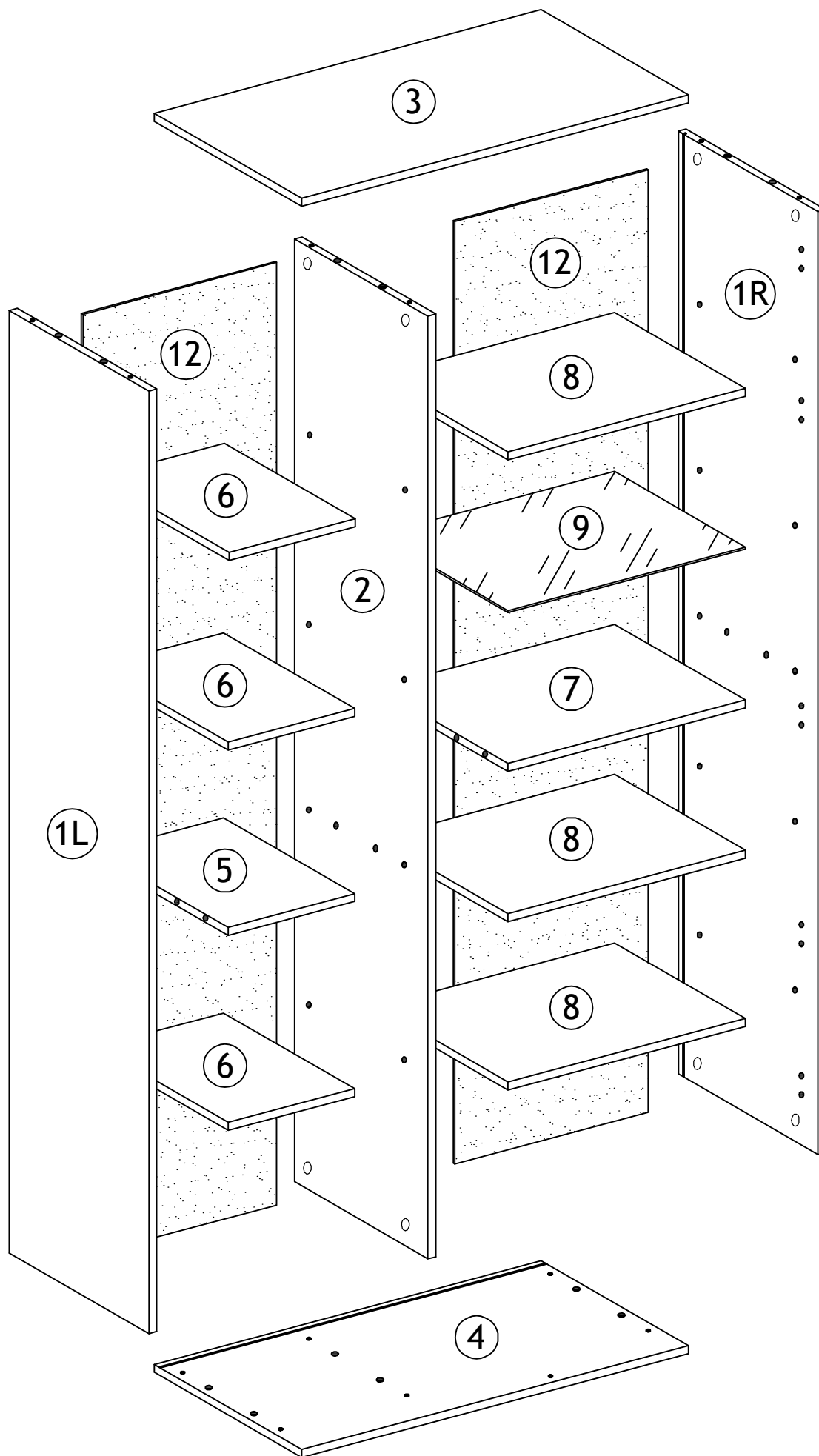

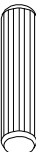
 <b>(K18)</b> H-120mm x4	 <b>(U6)</b> x4	 <b>(L1)</b> x9
 <b>(F3)</b> 6,3*13mm x18	 <b>(E11)</b> 4*16mm x34	 <b>(C1)</b> 6*43mm x20
 <b>(D1)</b> 15/16 x20	 <b>(D)</b> $\phi$ 20mm x20	 <b>(J1)</b> 5*16mm x24
 <b>(J4)</b> x2	 <b>(J3)</b> x4	 <b>(A1)</b> 8*30mm x20
 <b>(H2)</b> x14	 <b>(R3)</b> 1.4*25mm 10g	 <b>(R4)</b> N°4 x1
 <b>(U7)</b> x12	 <b>(Ea2)</b> 4,2*16mm x12	 <b>(S7)</b> 60x60x15 x1
 <b>(H5)</b> 8*50mm x2	 <b>(E16)</b> 4*60mm x2	 <b>(E5)</b> 3,5*16 x1
 <b>(I23)</b> x2	 <b>(E13)</b> 4*35mm x4	

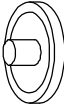
No	a*b	x
1L+R	1784x322	2
2	1784x308	1
3	800x340	1
4	800x340	1
5	261x302	1
6	261x302	3
7	489x302	1
8	489x302	3
9	481x294	1
10	313x395	3
10/1	636x378	1
10/2	423x378	1
11	395x1778	1
12	1793x387	2
13	L-1780	1

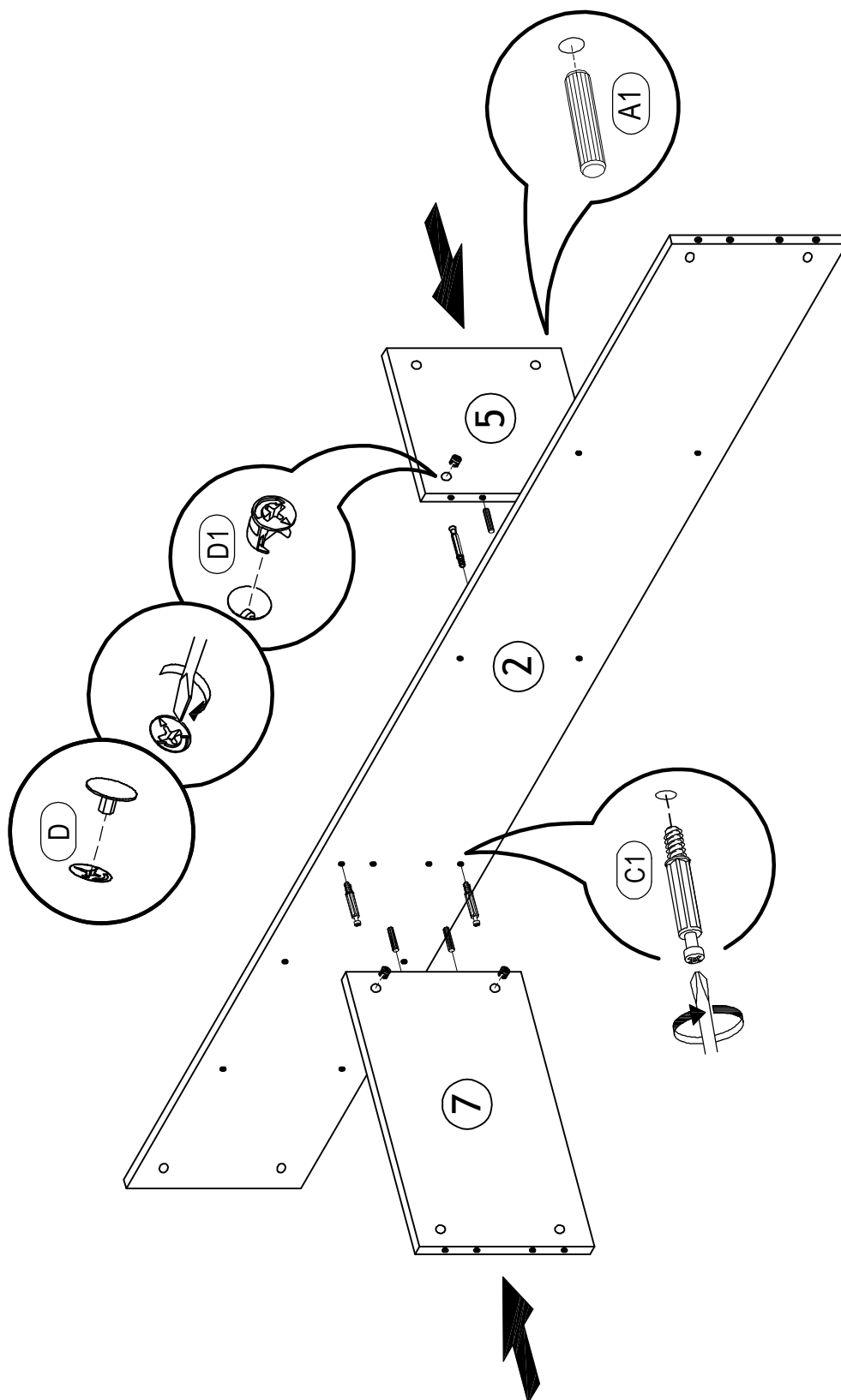

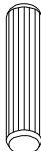

 <p>C1 6*43mm x4</p>	 <p>A1 8*30mm x4</p>	 <p>D1 15/16 x4</p>	 <p>D <math>\phi</math>20mm x4</p>
---	---	--	---

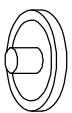

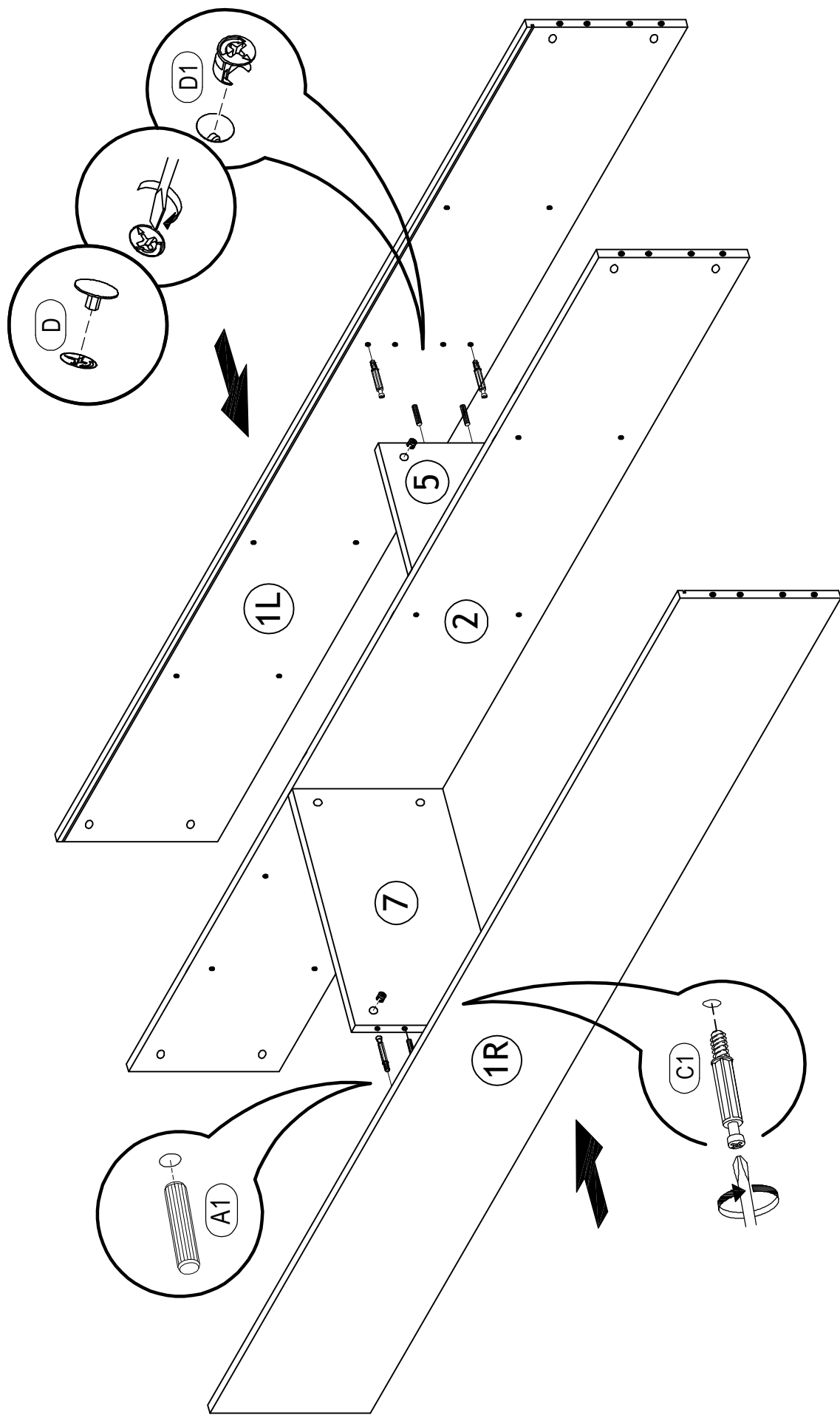
 <p>C1 6*43mm x4</p>	 <p>A1 8*30mm x4</p>	 <p>D1 15/16 x4</p>	 <p>D <math>\phi</math>20mm x4</p>
---	---	--	---

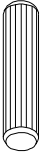

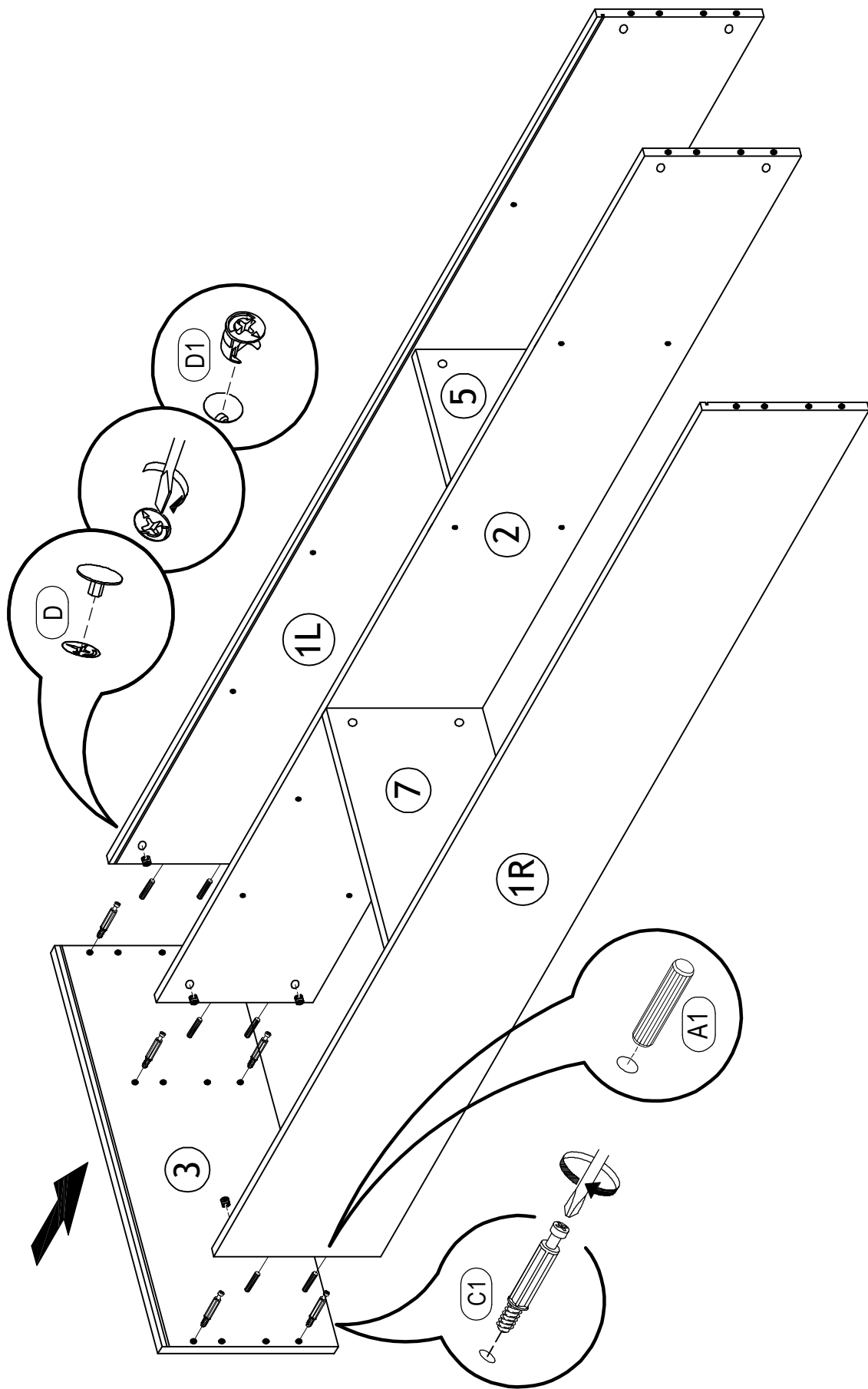

	C1	6*43mm	x6		A1	8*30mm	x6		D1	15/16	x6		D	ø20mm	x6
---	----	--------	----	---	----	--------	----	---	----	-------	----	---	---	-------	----

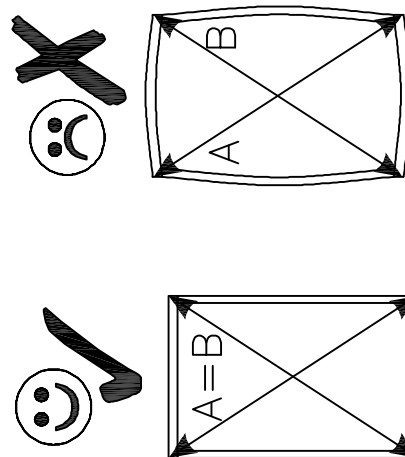
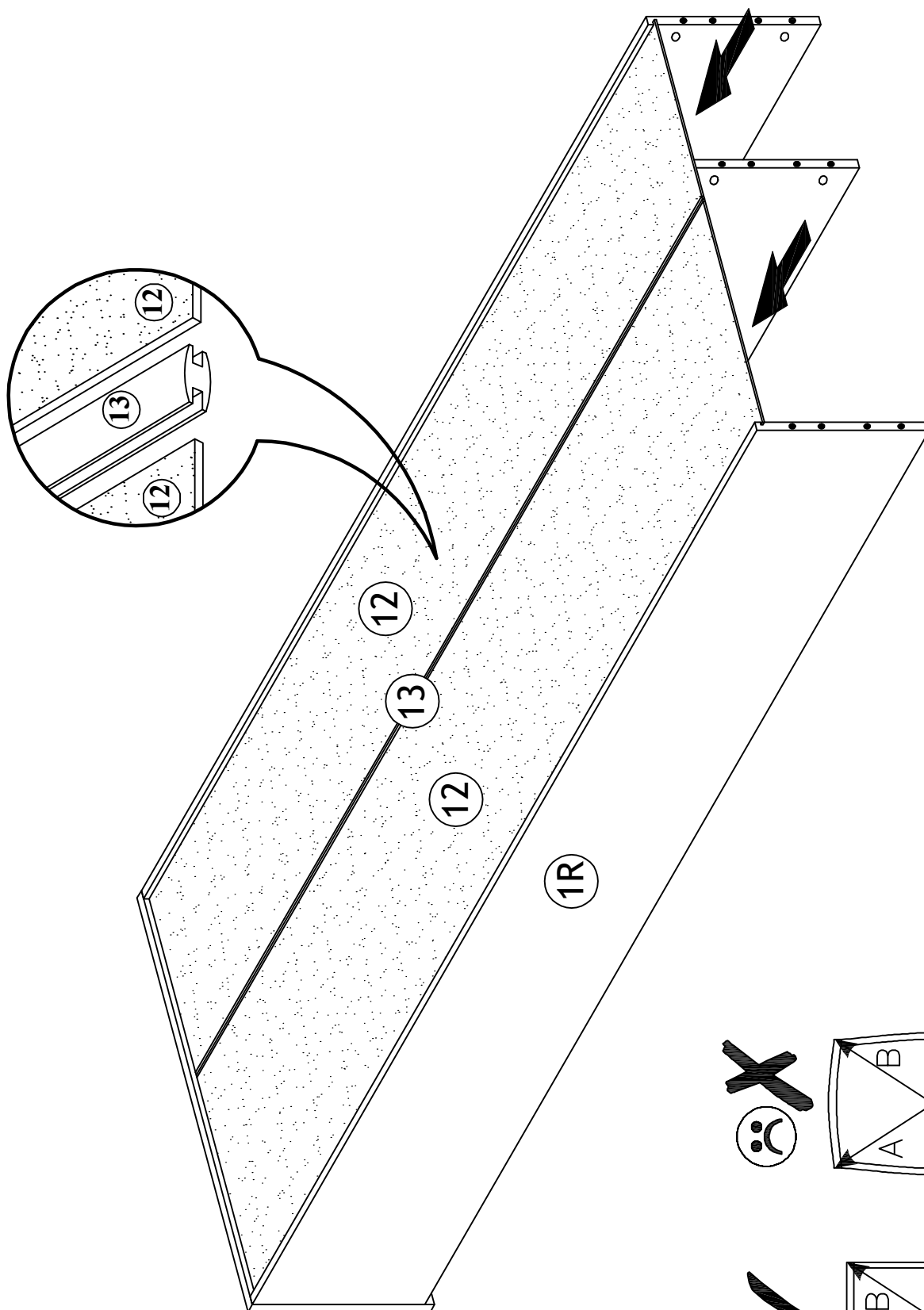



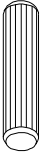



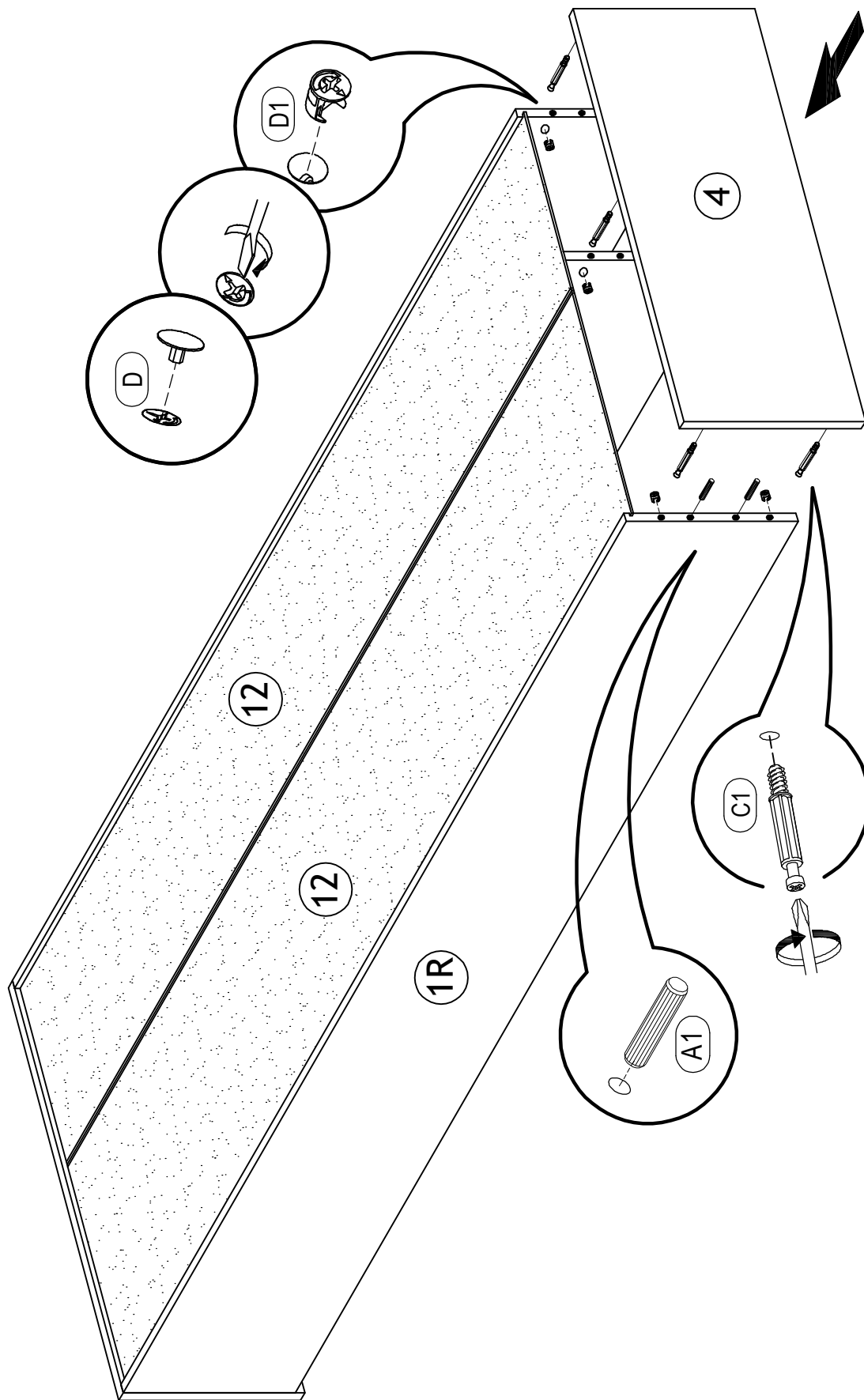

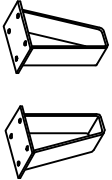
 <p>C1 6*43mm x6</p>	 <p>A1 8*30mm x6</p>	 <p>D1 15/16 x6</p>	 <p>D <math>\phi</math>20mm x6</p>
---	---	--	---

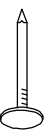

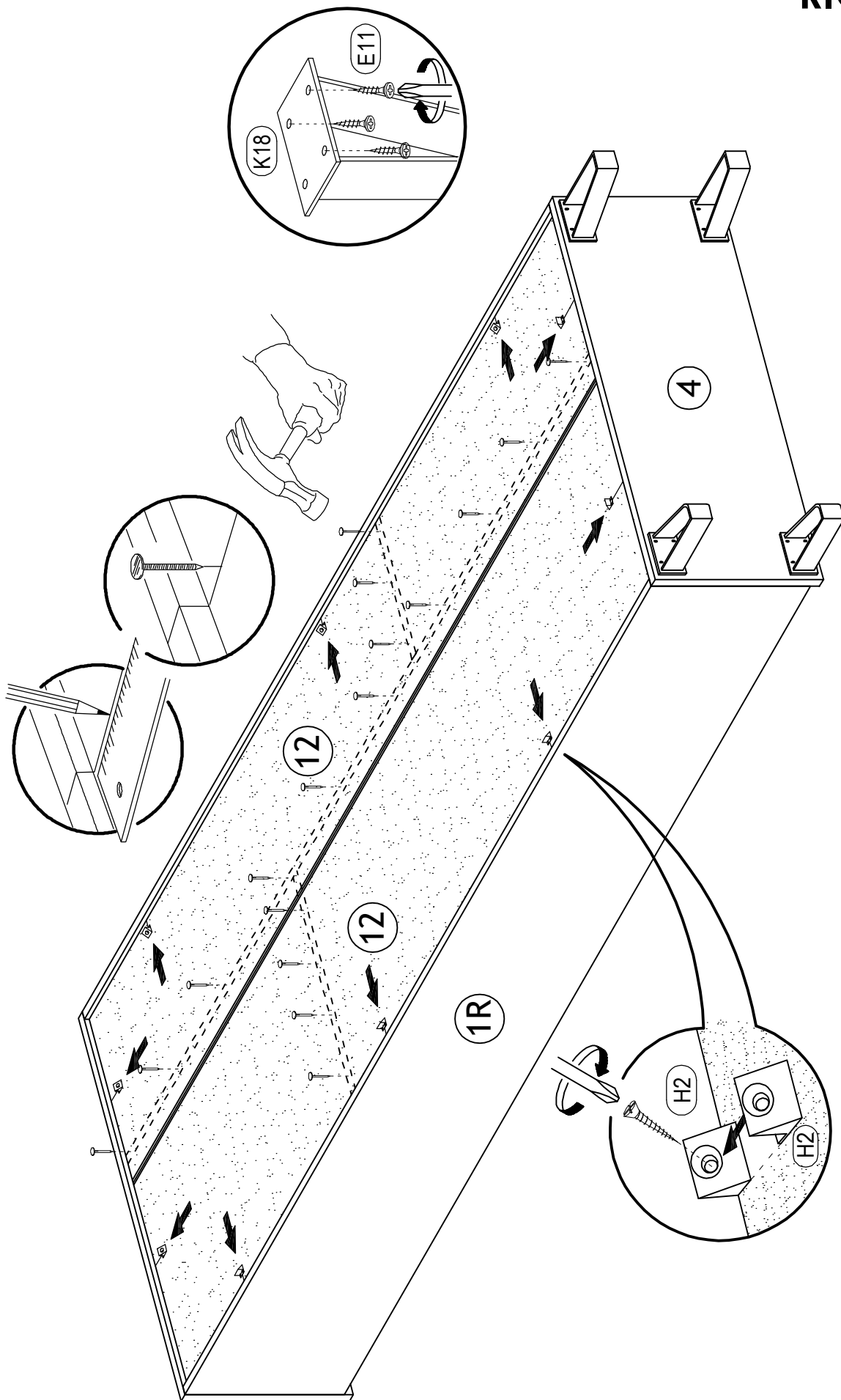

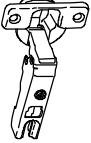

 <p>(H2) x10</p>	 <p>(K18) H-120mm x4</p>	 <p>(E11) 4*16mm x16</p>	 <p>(R3) 1.4*25mm x16</p>  <p>0.01kg</p>
---	---	---	--

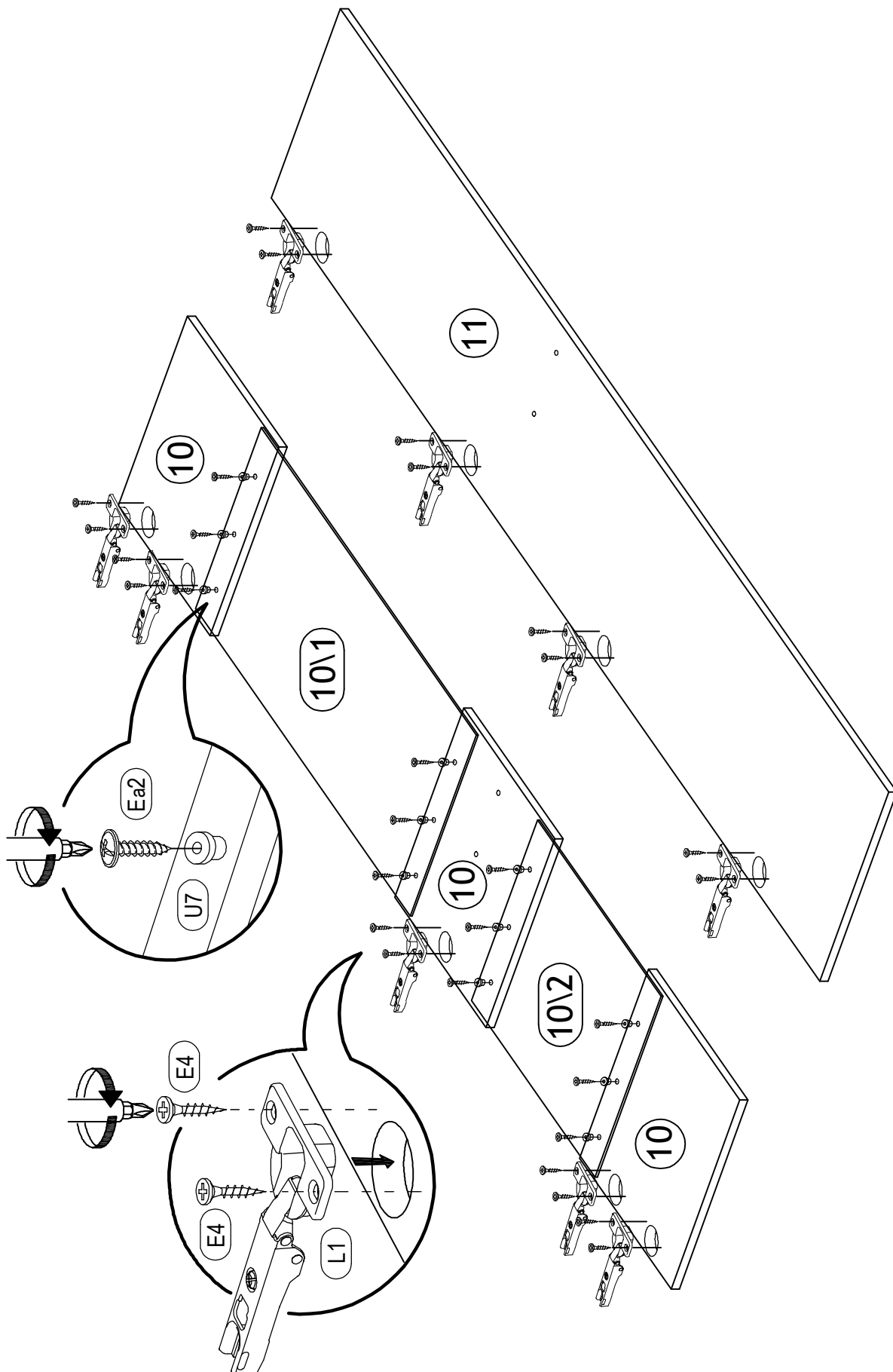

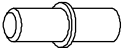

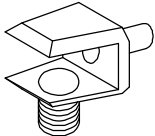
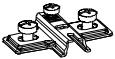
 (U7)	x12	 (Ea2) 4*16mm	x12	(E4) 3,5*16	x18	(L1)	 x9
---	-----	---	-----	-------------	-----	------	---

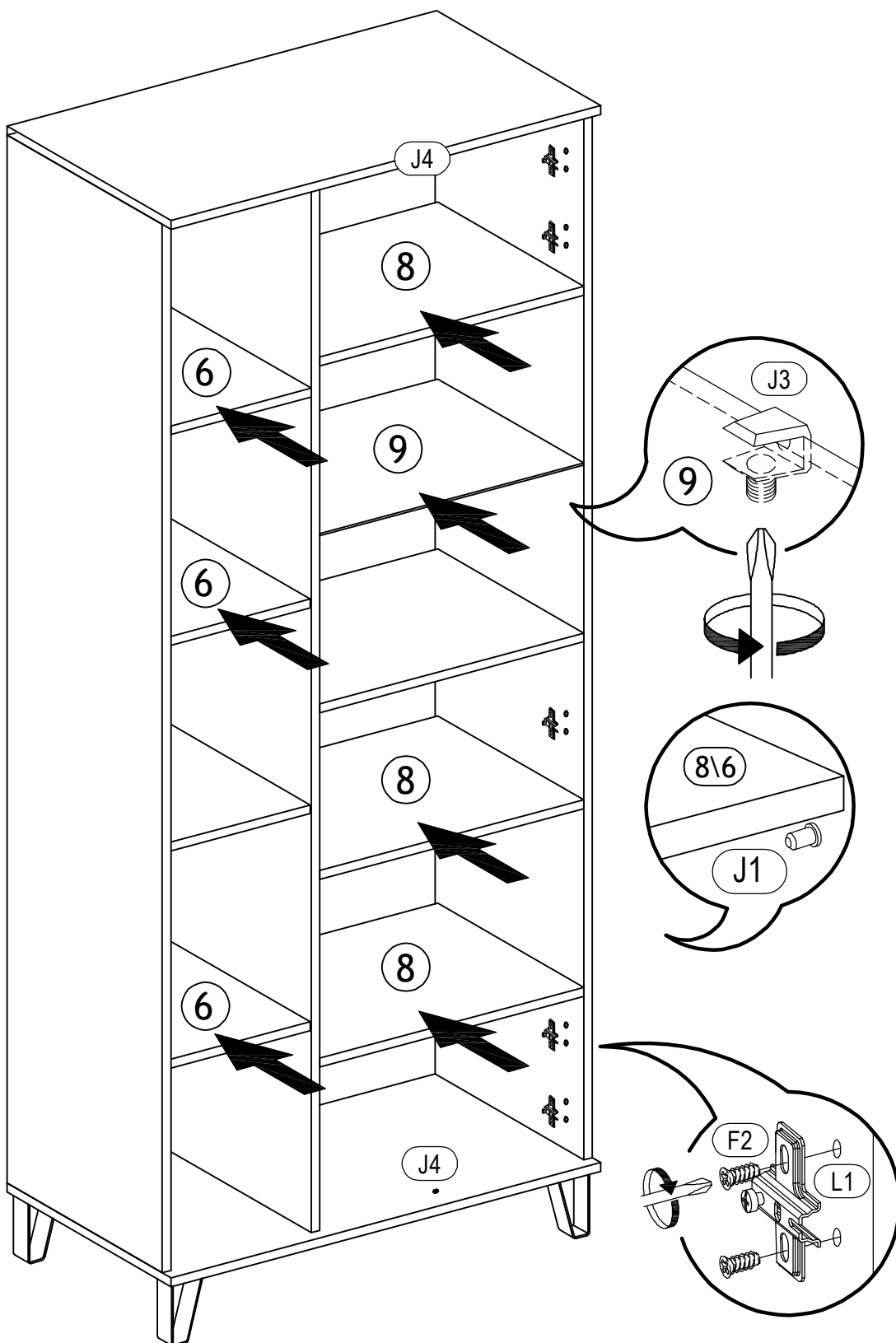

 J1 5*16mm x24	 J4 x2	 J3 x4
 L1 x9	 F2 6,3*13mm x18	

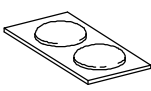

 E13 4*35mm x4	 I23 x2	 U6 x1
--	---	--

